



# Gentuity® High-Frequency OCT Imaging System

## User Manual



Item Number: 001845 Rev J  
September 2024

---

## Notice

Information provided within this document is subject to change without notice.

Gentuity, LLC shall not be liable for errors contained herein, or any omissions, or for indirect, incidental or consequential damages in connection with the furnishing, performance, or use of this material.

## Proprietary Information

This document contains proprietary information, which is protected by copyright.

## Limited Warranty

The “Limited Warranty” shipped with Gentuity, LLC products serves as the sole and exclusive warranty provided by Gentuity, LLC with respect to the products contained herein.

## Copyright

Copyright © 2024 Gentuity, LLC.

All Rights Reserved.

## Trademark Acknowledgments

Product names mentioned in this manual may be trademarks of their respective owners. Names and data used in examples are fictitious unless otherwise noted.

## Manufacturer

Gentuity, LLC  
142 North Road  
Suite G  
Sudbury, MA 01776-1142  
USA

**Telephone:** 888-967-7628

**General Inquiries:** [info@gentuity.com](mailto:info@gentuity.com)

**Support and Service:** [support@gentuity.com](mailto:support@gentuity.com)

**Website:** [www.gentuity.com](http://www.gentuity.com)

## Patents

[gentuity.com/patents-trademarks](http://gentuity.com/patents-trademarks)

---

**CAUTION!** Federal law restricts this device to sale by or on the order of a Physician licensed by law of the state in which he or she practices to use or order the use of the device.

---



# Contents

---

<b>Chapter 1: Introduction</b>	
About this document . . . . .	1-1
Indications for Use . . . . .	1-1
Contraindications . . . . .	1-1
Safety Overview . . . . .	1-2
Complications . . . . .	1-2
Intended Users . . . . .	1-2
Conventions Used in this Document . . . . .	1-3
Warning and Caution Conventions . . . . .	1-3
<b>Chapter 2: Safety Information</b>	
General Safety . . . . .	2-1
Patient Safety . . . . .	2-2
Operator Safety . . . . .	2-3
Light Emission Hazards . . . . .	2-3
Moving the System . . . . .	2-3
Catheter Safety . . . . .	2-4
Console Safety . . . . .	2-6
Electrical Safety . . . . .	2-6
Avoiding Electrical Hazards . . . . .	2-6
Making Proper Electrical Connections . . . . .	2-7
Electromagnetic Compatibility . . . . .	2-7
Electromagnetic Interference . . . . .	2-7
Electromagnetic Safety . . . . .	2-8
Data Considerations . . . . .	2-11
Cybersecurity Considerations . . . . .	2-12
Gentuity Security Controls . . . . .	2-12
Gentuity Recommended Security Practices . . . . .	2-13
Software Information . . . . .	2-13
Cybersecurity-Related Cautions . . . . .	2-14
<b>Chapter 3: System Overview</b>	
Overview . . . . .	3-1
System Components . . . . .	3-2
Input/Output Connections . . . . .	3-4
Probe Interface Module (PIM) . . . . .	3-5
Catheter . . . . .	3-6
<b>Chapter 4: System Setup</b>	
Positioning the System . . . . .	4-1
Connecting and Powering On the System . . . . .	4-1
Logging Onto the System . . . . .	4-2
Logging Out of the System . . . . .	4-3
Shutting Down the System . . . . .	4-3
Setting Up the Monitor . . . . .	4-4
Setting Display Monitor Positions . . . . .	4-4
Connecting an External Monitor . . . . .	4-4

Connecting Video Input from an Angiography System . . . . .	4-5
Selecting the Procedure Room . . . . .	4-6
Preparing the PIM. . . . .	4-7
Configuring System Settings . . . . .	4-8
About the Administrator Password. . . . .	4-9
Configuring General Settings. . . . .	4-10
Setting the Lock Screen . . . . .	4-13
Configuring Acquisition Settings . . . . .	4-14
Configuring Review Settings . . . . .	4-16
Configuring Maintenance Settings . . . . .	4-17
<b>Chapter 5: Patient Records</b>	
Accessing the Patient List. . . . .	5-1
Adding a Patient Record. . . . .	5-2
Searching for a Patient Record . . . . .	5-4
Opening a Patient Record . . . . .	5-5
Editing Patient Information . . . . .	5-6
Pinning a Patient Record . . . . .	5-7
<b>Chapter 6: Performing an HF-OCT Procedure</b>	
Overview . . . . .	6-1
Required Materials and Equipment . . . . .	6-2
Setting up the System. . . . .	6-2
Using the Imaging Catheter . . . . .	6-3
Connecting the Catheter to the PIM. . . . .	6-3
Inserting and Positioning the Catheter. . . . .	6-4
Confirming Imaging Settings . . . . .	6-4
Preparing the Flush Media. . . . .	6-6
Beginning Preview (Optional) . . . . .	6-7
Enabling the Start of High-Speed Rotation. . . . .	6-9
Injecting Flush Media and Initiating Pullback. . . . .	6-10
Removing the Catheter . . . . .	6-11
Completing the Exam . . . . .	6-11
<b>Chapter 7: Reviewing HF-OCT Recordings</b>	
Overview . . . . .	7-1
Image Screen. . . . .	7-2
Menu Bar. . . . .	7-4
Angio View . . . . .	7-5
2D View . . . . .	7-6
Current Slice Information Panel . . . . .	7-7
Lumen Profile Display. . . . .	7-8
Reference Markers and Playback Controls. . . . .	7-11
Navigating the Pullback . . . . .	7-12
Areas of Uncertainty . . . . .	7-13
Additional View Modes . . . . .	7-16
Stent Expansion . . . . .	7-16
Bifurcation Tool . . . . .	7-18

L-Mode. . . . .	7-19
Limitations. . . . .	7-19
3D View . . . . .	7-20
Fly-Through View . . . . .	7-21
Viewing Pullback Information . . . . .	7-22
<b>Chapter 8: Measurements and Annotations</b>	
Measurements and Annotations in the Image Files . . . . .	8-1
Measurement and Annotation Tools . . . . .	8-2
Techniques to Improve Measurement Accuracy . . . . .	8-3
Measurements and Annotations in L-Mode View . . . . .	8-3
Linear and Longitudinal Measurements. . . . .	8-4
Performing a Linear or Longitudinal Measurement. . . . .	8-5
Area Measurements . . . . .	8-6
Performing an Area Measurement . . . . .	8-7
Annotations. . . . .	8-8
Adding Annotations . . . . .	8-8
Angle Measurements . . . . .	8-9
Performing an Angle Measurement . . . . .	8-10
Measurement Results Tag . . . . .	8-11
<b>Chapter 9: Exporting Patient Records and Pullbacks</b>	
Overview . . . . .	9-1
Exporting Via USB Connected Media . . . . .	9-1
Exporting Via Connected DICOM PACS Server . . . . .	9-2
Restricting Access to USB Drive . . . . .	9-2
Configuring Network Server Settings for Export . . . . .	9-3
Viewing Network Adapter Information . . . . .	9-3
Configuring Network Export Server(s) . . . . .	9-4
Exporting Patient Records from the Patient List . . . . .	9-7
Exporting Pullbacks and Images to a USB Drive . . . . .	9-12
Exporting Pullbacks. . . . .	9-12
Exporting Images . . . . .	9-15
Export File Formats. . . . .	9-17
Export Settings . . . . .	9-19
File Naming Conventions . . . . .	9-20
<b>Chapter 10: Cleaning the System</b>	
Overview . . . . .	10-1
Routine Cleaning Procedures. . . . .	10-1
Items Required for Cleaning . . . . .	10-1
Cleaning the System. . . . .	10-2
Cleaning the PIM. . . . .	10-2
<b>Chapter 11: Support and Maintenance</b>	
Contact Information . . . . .	11-1
Troubleshooting . . . . .	11-2
Software Logs . . . . .	11-3
Disposal . . . . .	11-3

<b>Chapter 12: Specifications</b>	
System Specifications . . . . .	12-1
System Height and Weight . . . . .	12-1
Monitors . . . . .	12-1
Environmental Specifications . . . . .	12-2
System Optical Specifications . . . . .	12-2
Clinical Imaging Specifications . . . . .	12-3
Electrical Specifications . . . . .	12-3
Safety Standards Compliance . . . . .	12-4
<b>Chapter 13: Glossary of Symbols</b>	
System Symbols . . . . .	13-1
System Packaging Symbols . . . . .	13-4
Catheter Symbols . . . . .	13-6



# Chapter 1

## Introduction

This chapter provides an introduction to the Genuity® High-Frequency OCT Imaging System.

---

### About this document

This document describes the Genuity High-Frequency OCT Imaging System and includes:

- Descriptions of the system components and user interface
- Procedures for using the Optical Coherence Tomography (OCT) imaging system
- System safety and cleaning information
- System specifications

### Indications for Use

The Genuity® HF-OCT Imaging System with Vis-Rx® Micro-Imaging Catheter is intended for intravascular imaging and is indicated for use in coronary arteries in patients who are candidates for transluminal interventional procedures. The Vis-Rx Micro-Imaging Catheter is intended for use in vessels 1.3 to 6.0 mm in diameter. The Vis-Rx Micro-Imaging Catheter is also intended for use prior to or following transluminal interventional procedures. The Vis-Rx Micro-Imaging Catheter is not intended for use in a target vessel that has undergone a previous bypass procedure.

### Contraindications

Contraindications for use of the Genuity High-Frequency OCT Imaging System include:

- Bacteremia or sepsis
- Major coagulation system abnormalities
- Coronary artery spasm
- Severe hemodynamic instability or shock
- Total occlusion
- Large thrombus
- Acute renal failure
- Patients disqualified for CABG surgery
- Patients disqualified for PTCA

## Safety Overview

This section lists safety-related information. For detailed safety-related information, see “Safety Information” on page 2-1.

---

**Note** — Before creating an OCT recording, review “Performing an HF-OCT Procedure” on page 6-1 for additional cautions and warnings.

---

## Complications

The risks involved in vascular imaging include those associated with all catheterization procedures. The following complications (listed alphabetically) may occur as a consequence of intravascular imaging and may necessitate additional medical treatment including surgical intervention.

- Acute myocardial infarction or unstable angina
- Allergic reaction to the contrast media
- Arterial dissection, injury, or perforation
- Cardiac arrhythmias
- Coronary artery spasm
- Death
- Embolism
- Myocardial ischemia
- Renal insufficiency from contrast usage
- Thrombus formation

## Intended Users

The device is intended to be used by physicians and technicians trained in the performance of catheter-based intracoronary interventional procedures. These physicians are interventional cardiologists. The interventional cardiologist will frequently be assisted by an interventional cardiology fellow, catheterization laboratory technician, or nurse.

---

## Conventions Used in this Document

In addition to the traditional mouse and keyboard, the Genuity High-Frequency OCT Imaging System uses a touchscreen for user interaction with the system.

The following conventions, abbreviations, and shortened expressions are used throughout this manual.

**Table 1-1 Document Conventions**

Item	Description
Select	If using the touchscreen, indicates touching the item on the screen to select it. If using the mouse, indicates clicking the left mouse button on the item to select it.
Drag	Moving an item on the screen by selecting it and dragging it to another location
Pinch	Moving two or more fingers together or apart on the touchscreen to zoom in and out on an image. You can also use Ctrl+scroll wheel on the mouse to zoom in and out.
Zoom	
Pan	When the image is in a zoomed state, use your fingers to pan the image (move it around the screen).
On-screen text and button labels	Displayed in the documentation as bold type. For example, the <b>Patient List</b> , <b>Settings</b> icon, and so on.
<b>SO</b> <b>NSO</b>	In procedures where a sterile operator is required, <b>SO</b> and <b>NSO</b> preceding the step indicates who performs each step: Sterile Operator ( <b>SO</b> ) or Non-Sterile Operator ( <b>NSO</b> ).

## Warning and Caution Conventions

The following conventions are used throughout this manual to highlight safety concerns:

---



---

**WARNING!** A warning indicates conditions, hazards, or unsafe practices that may result in injury or death.

---



---



---



---

**CAUTION!** A caution indicates conditions, hazards, or unsafe practices that may result in damage to the device, loss of data, or image misinterpretation.

---



---



# Chapter 2

## Safety Information

This chapter provides important safety information for using the Genuity High-Frequency OCT Imaging System. For quick reference, this Safety Information chapter lists all of the warnings and cautions that are listed throughout the manual. Be sure to pay attention to the warnings and cautions as listed in the chapters that follow in the context in which they apply.

---

### General Safety

To avoid potential hazards to patients, operators, equipment, and data loss, follow the warnings and cautions listed in this section and throughout the manual.

---

---

#### WARNINGS!

- The Genuity High-Frequency OCT Imaging System is intended for use only by medical personnel trained in its operation and skilled in the clinical procedures to be used.
  - Medical personnel who use the Genuity High-Frequency OCT Imaging System must be aware of the system's limitations. Only trained operators can determine if the use of the Genuity High-Frequency OCT Imaging System is appropriate.
  - Always use controls, make adjustments, and perform procedures as specified in this User Manual.
  - Always read and follow the *Instructions for Use* supplied with the compatible Imaging Catheter.
- 
- 

---

#### CAUTIONS!

- The system components are integral parts of the Genuity High-Frequency OCT Imaging System. The Genuity High-Frequency OCT Imaging System hardware and software must not be modified in any way by the user. Making such modifications may interfere with correct operation and will void system warranties. Contact Genuity Support for more information.
  - The Genuity High-Frequency OCT Imaging System can only be connected to angiography systems that have been set up by Genuity Support.
-

---

## Patient Safety

To avoid any potential hazard to patients, follow the warnings and cautions outlined in this section, in “Catheter Safety” on page 2-4, and throughout this manual.

---

---

### WARNINGS!

- Appropriate anticoagulant and vasodilator therapy must be used during the procedure as needed.
- The catheter is sterilized by irradiation and is intended for one time use only. Do not reuse, re-sterilize, or reprocess. Reuse or re-processing could result in a degradation of catheter material or patient infection.
- Non-pyrogenic. Do not use the catheter if the package is opened or damaged.
- Do not use the catheter after the expiration date, or if there is not a date on the package.
- The catheter is not compatible with magnetic resonance imaging (MRI).
- Refer to the contrast media’s instructions for general warnings and precautions relating to contrast media.
- Make sure to use the contrast media and injectors according to injection specifications given by the manufacturers. Excessive flow rate and pressure may damage the blood vessel or devices used with the catheter. Low flush rate may result in a faint image.
- Selecting the wrong flush media can cause measurement errors which could lead to incorrect treatment. Prior to acquisition, make sure the flush media identified in the **Pullback Settings** window matches the flush media you are using.

---

---

**Note** — Prior to use, please review the *Instructions for Use* supplied with the Imaging Catheter for more information.

---

---

## Operator Safety

To avoid any potential hazard to operators and patients, follow the warnings, cautions, and statements outlined in this section and throughout this manual.

### Light Emission Hazards

This product has been determined under IEC 60825-1:2014 to be a Class 1 Laser Product.

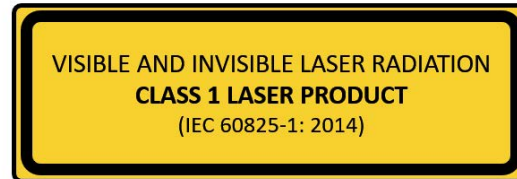

Complies with 21 CFR 1040.10 and 1040.11 except for conformance with IEC 60825-1 Ed. 3 and IEC 60601-2-22 Ed. 3.1, as described in Laser Notice No. 56, dated May 8, 2019

### Moving the System

To avoid potential hazards to operators and equipment when moving the system, follow the warnings and cautions outlined in this section and throughout this manual.

---

#### WARNINGS!

- The system weighs up to 70 kg (154 lb). Use caution when moving the system.
  - To avoid a potential tripping hazard and possible equipment damage, before beginning a system move, make sure the system is off, the Ethernet cable is disconnected from the console (if applicable), the system's power cord is disconnected from the wall outlet, and the power cord is secured on the cord wrap on the back of the system.
  - To avoid a potential tripping hazard and possible equipment damage, position the PIM cable appropriately before moving the system.
  - To eliminate the potential danger of the system tipping over, make sure that the system's wheels roll freely before beginning the move. Resolve any wheel problems before you move the system. Be sure the system brakes are in the up position (unlocked).
  - To eliminate the potential danger of the system tipping over, avoid ramps that are steeper than 10 degrees. Wheelchair ramps usually have an incline of less than 5 degrees.
  - To eliminate the potential danger of the system tipping over, use two people if you must move the system up or down ramps with an incline of more than 10 degrees.
-

---

## Catheter Safety

To avoid any potential hazards to patients, operators, or equipment when using the Imaging Catheter, follow the warnings and cautions outlined in this section, in “Patient Safety” on page 2-2, and throughout this manual.

---

---

### WARNINGS!

- Prior to use and for more detailed information, refer to the *Instructions for Use* provided with the Imaging Catheter.
- The catheter is sterilized by irradiation and is intended for one time use only. Do not reuse, re-sterilize, or reprocess. Reuse or re-processing could result in a degradation of catheter material or patient infection.
- Observe sterile technique when connecting the catheter to the PIM, which is outside of the sterile field.
- Do not disconnect the Imaging Catheter from the PIM until the procedure is complete to avoid a sterility breach.
- To avoid risk of air embolism, the catheter lumen must be purged prior to insertion and imaging.
- Observe all advancement and movement of the Imaging Catheter under fluoroscopy. Always advance and withdraw the catheter slowly. Failure to observe device movement fluoroscopically may result in vessel injury or device damage.
- Leave the guidewire engaged with the catheter at all times during use. Do not withdraw or advance the guidewire prior to withdrawing the catheter.
- If resistance is encountered during advancement or withdrawal of the Imaging Catheter, stop manipulation and evaluate under fluoroscopy. If the cause of resistance cannot be determined or mitigated, carefully remove the catheter and guidewire together.
- If the Imaging Catheter becomes kinked, stop manipulating it to avoid vessel injury or Imaging Catheter damage.
- The catheter should never be forced into lumens that are narrower than the catheter body.
- To avoid vessel damage, maintain the position of the guidewire when manipulating the Imaging Catheter in the vessel.
- When advancing or withdrawing a catheter with a minirail tip through a stented vessel, the catheter may engage the stent between the junction of the catheter and guidewire, resulting in entrapment of catheter/guidewire, catheter tip separation, and/or stent dislocation.
- Before injecting flush media, be sure that the hemostasis valve is tightened to reduce the risk of unintended catheter movement or leaking of flush media during injection.
- To avoid vessel damage or catheter damage, do not push the guide catheter further into the blood vessel when removing the catheter.



---

**CAUTIONS!**

- The purge must be performed prior to insertion and imaging. The syringe should be left attached to the side-arm to allow repeated purging throughout the imaging procedure and to maintain a static pressure to prevent backflow.
  - Purge the catheter lumen only with saline to ensure optimal image quality.
  - Do not remove the syringe from the catheter purge port to prevent air from entering the purge lumen and to allow repurging as necessary.
  - Use a guidewire with a maximum outer diameter of 0.014" (0.36 mm) and a guide catheter with a minimum inner diameter of 0.068" (1.73 mm).
  - To help ensure successful imaging, do not use a guide catheter with side holes.
  - To avoid catheter damage, make sure the PIM motor is NOT running when inserting the Imaging Catheter into the guide catheter.
  - To help ensure successful imaging, the guide catheter should be oriented to preferentially direct the flush media flow to the target artery.
  - To ensure imaging of selected anatomy, do not move the guidewire after the Imaging Catheter is in position.
  - If the optical imaging core encounters resistance while returning to the distal position within the sheath (due to a kink or breakage), the Advance Force Limiter will buckle to absorb the forward motion. If this occurs, carefully remove the Imaging Catheter from the guide catheter. Replace with a new catheter if further imaging is required.
-

---

## Console Safety

The Genuity High-Frequency OCT Imaging System disables light output and disables all PIM motors in the following situations:

- Catheter breakage is detected
- A critical system error is detected
- Pressing the **STOP** button on the PIM or the stop button on the touchscreen

---

### CAUTIONS!

- When there is no catheter connected to the PIM, be sure the PIM connector cover is securely in place to protect from dirt and damage.
  - When not in use, always store the PIM in the PIM cradle with the PIM connector cover facing down.
  - Protect the PIM connection ports and the catheter connectors from fluids.
  - Do not touch the internal optics of the optical connector on the catheter or on the PIM.
- 

## Electrical Safety

To avoid any potential hazards to patients, operators, or equipment when using the Genuity High-Frequency OCT Imaging System, follow the electrical safety warnings and cautions outlined in this section and throughout this manual.

## Avoiding Electrical Hazards

---

---

**WARNING!** Do NOT remove system covers. Only personnel qualified by Genuity should service the system. Accidentally contacting the electrical circuits inside the housing could cause serious injury or death.

---

---

## Making Proper Electrical Connections

Ensure the electrical connection for the system is properly rated. Carefully follow the safety guidelines described in this section when connecting the Genuity High-Frequency OCT Imaging System's power cord to the hospital or lab's AC outlet.

---

---

### WARNINGS!

Failure to follow the electrical connection warnings below causes the system and its use to be out of compliance with regulations and places the patient and the operator at risk of injury or death and may damage the equipment.

- Connect the system only to properly grounded (three-hole) hospital-grade AC outlets.
  - Do not use extension cords.
  - The circuit must accommodate an additional load of up to 600 VA.
- 
- 

**Note** — If the Genuity High-Frequency OCT Imaging System is used with peripherals that are powered from a separate wall outlet, then the combination is considered to be a Medical System. It is the user's responsibility to comply with IEC 60601-1 and test the Medical System according to the requirements.

---

## Electromagnetic Compatibility

The Genuity High-Frequency OCT Imaging System is designed to meet the following electromagnetic compatibility standard: IEC 60601-1-2 (US and International)

## Electromagnetic Interference

The system produces images by using digital signal processing techniques that operate in the radio frequency (RF) energy range. The system is therefore susceptible to interference generated by other RF energy sources such as medical devices, information technology products, or radio/television transmission towers. Tracing the source of radiated interference can be difficult.

In accordance with the standards identified in this user manual, no interference was observed. However, the trained user must determine if an artifact caused by electromagnetic disturbances will negatively impact image quality and the subsequent study results.

To help identify the source of electromagnetic interference, answer the following questions before contacting Genuity Support. The answers will help Genuity determine if the problem is in the system or in the imaging environment.

- Is the interference intermittent or constant?
- Does the interference occur with one catheter only, or with every Imaging Catheter?
- Is the interference present if the system is moved to a different location in the facility?

## Electromagnetic Safety

The Genuity High-Frequency OCT Imaging System has been tested for compliance with the Safety Requirements of International Electromagnetic standard IEC 60601-1-2 (2014) and EN 60601-1-2 (2015) for use in the Hospital Environment. This means the Essential Performance, listed below, has been verified in the presence of reasonably expected Electromagnetic Disturbances that may occur in a Hospital.

The Essential Performance (safety related performance) of the Genuity High-Frequency OCT Imaging System is to perform pullback acquisition when and only when initiated by the operator. A pullback acquisition comprises catheter rotation, pullback, and re-advance.

In addition to the requirements of International Electromagnetic Safety standard IEC 60601-1-2, the Genuity High-Frequency OCT Imaging System has been tested for compatibility with Radio Frequency Identification Devices (RFID).

In order to ensure Electromagnetic Safety, the following warnings must be followed:

---

---

### WARNINGS

- Use of this equipment adjacent to or stacked with other equipment should be avoided because it could result in improper operation. If such use is necessary, this equipment and the other equipment should be observed to verify that they are operating normally.
  - The Genuity High-Frequency OCT Imaging System was not tested for compatibility with HF Surgical Equipment or Magnetic Resonance Imaging Systems and should not be used near this equipment without first testing for proper operation.
  - Portable RF communications equipment (including peripherals such as antenna cables and external antennas) should be used no closer than 30 cm (12 inches) to any part of the Genuity High-Frequency OCT Imaging System, including cables specified by Genuity. Otherwise, degradation of the performance of this equipment could result.
- 
- 

**Note** — The radiated and conducted EMISSIONS characteristics of the Genuity High-Frequency OCT Imaging System make it suitable for use in industrial areas and hospitals (CISPR 11 class A). If it is used in a residential environment (for which CISPR 11 class B is normally required) this equipment might not offer adequate protection to radio-frequency communication services. The user might need to take mitigation measures, such as relocating or re-orienting the equipment. (CISPR 11 is an International Standard for Radiated and Conducted Emissions).

---

Table 2-1 provides information regarding electromagnetic disturbances and the immunity levels of each disturbance for the Genuity High-Frequency OCT Imaging System. These levels are the reasonably expected level for the Hospital Environment.

**Table 2-1 Electromagnetic Disturbances and Immunity Levels**

Electromagnetic Disturbance Type	International Standard	Levels Tested	Guidance on the Electromagnetic Environment
Electrostatic discharge (ESD)	IEC 61000-4-2	±8 kV for contact discharge and ±2 kV, ±4 kV, ±8 kV, ±15 kV for air discharge	Floors should be wood, concrete or ceramic tile. If floors are covered with synthetic material, the relative humidity should be at least 50%.
Radio frequency (RF) fields from fixed RF communications equipment	IEC 61000-4-3	3 V/m from 80 MHz to 2.7 GHz	Medical Equipment should be separated at minimum distance $d$ from fixed RF communications equipment where $d=2.3 \times P^{1/2}$ and $P$ is the transmitted power in Watts.
Radio frequency (RF) fields from portable and mobile RF communications equipment	IEC 61000-4-3	27 V/m from 380–390 MHz 28 V/m from 430–470 MHz 9 V/m from 704–787 MHz 28 V/m from 800–960 MHz 28 V/m from 1700–1990 MHz 28 V/m from 2400–2570 MHz 9 V/m from 5100–5800 MHz	Medical Equipment should be separated at minimum distance of 30 cm (12") from portable and mobile RF communications equipment.
Electrical transient bursts	IEC 61000-4-4	± 2 kV @ 100kHz (Mains) ± 1 kV @ 100kHz (I/O Lines)	Mains power quality should be that of a typical commercial or hospital environment.
Lightning Surge	IEC 61000-4-5	±0,5 kV, ±1 kV, ±2 kV from Mains lines to Earth and ±0,5 kV, ±1 kV from Mains Line-to-line	Mains power quality should be that of a typical commercial or hospital environment.
Conducted RF	IEC 61000-4-6	3Vrms from 150 kHz to 30 MHz and 6Vrms in ISM bands	Portable and mobile RF communications equipment can induce voltage into cable which may interfere with normal operation of the Genuity High-Frequency OCT Imaging System.
Power frequency magnetic fields	IEC 61000-4-8	30 A/m @ 50 Hz and 60 Hz	Motors, transformers, and power lines can generate high magnetic fields which may interfere with Medical Equipment. If interference occurs to the Genuity High-Frequency OCT Imaging System, separate the Genuity High-Frequency OCT Imaging System and interfering source.

**Table 2-1 Electromagnetic Disturbances and Immunity Levels (Continued)**

Electromagnetic Disturbance Type	International Standard	Levels Tested	Guidance on the Electromagnetic Environment
Magnetic fields from RFID	IEC 61000-4-39	65 A/m @ 134.2 kHz 7.5 A/m @ 13.56 MHz	Radio Frequency Identification Devices (RFID) can cause interference with Medical Equipment. If interference occurs to the Genuity High-Frequency OCT Imaging System, separate the Genuity High-Frequency OCT Imaging System and RFID.
Voltage dips	IEC 61000-4-11	100 V @ 60 Hz and 230 V @ 50 Hz	Short interruptions in the AC power may cause Medical Equipment to stop functioning. The Genuity High-Frequency OCT Imaging System is immune to most Voltage dips.
Power interruptions	IEC 61000-4-11	100 V @ 60 Hz and 230 V @ 50 Hz	Interruptions in the AC power will cause the Genuity High-Frequency OCT Imaging System to stop functioning if not backed up by battery power.

---

**Note —** The Genuity High-Frequency OCT Imaging System transmits and receives radio frequency energy at 13.56 MHz +/- 7 kHz and is used as a Radio Frequency Identification Device (RFID) for identifying the catheter being used. The RFID system utilizes on-off keying modulation which has a bandwidth of approximately 500 kHz. The transmitting field level is approximately 7.5 A/m. The transmitter is only active during the setup procedure to read the RFID tag in the catheter.

---

---

## Data Considerations

To avoid any possible image misinterpretation or potential data loss when using the Genuity High-Frequency OCT Imaging System, follow the warnings, cautions, and statements outlined in this section and throughout this manual.

---

### CAUTIONS!

- Cardiac motion relative to the catheter can cause lengthening and shortening of longitudinal segments of the Lumen Profile and L-Mode, or can create a jagged appearance of the reconstructed image. Do not rely solely on the Lumen Profile or L-Mode for longitudinal measurements.
  - Use caution when interpreting the low confidence slices or placing reference markers on a low confidence slice. If measurements are present, you can manually adjust the lumen trace to more accurately identify the lumen boundary.
  - Because image data is displayed centered around the catheter, off-center catheter locations can make the lumen appear significantly smaller than actual diameter in some L-Mode views. When viewing in L-Mode, rotate the cut-plane to avoid image misinterpretation.
  - Deleting files from the system frees up storage space on the system but the deleted files cannot be imported back into the system.
  - Do not use images that have been exported in standard formats (such as MP4, JPEG, and PDF) for clinical decision making. This format uses compression methods that may degrade the image quality.
  - Files exported using the Genuity format have .g2raw and .patient file extensions. Changing the filename or extension of files exported using the Genuity format may result in the loss of exported information. Genuity recommends not changing these filenames or extensions.
  - Using non-OCT software to measure standard format images will not produce accurate measurements.
  - If you want to make measurements on files which will be exported in standard formats (such as MP4, JPEG, and PDF), you must make the measurements BEFORE exporting the images.
-

## Cybersecurity Considerations

Gentuity follows an established security product development framework, including threat modeling, to assess threats and security risks, and identify and implement appropriate security controls to mitigate risks. The Gentuity High-Frequency OCT Imaging System primary security controls are summarized below under Gentuity Security Controls. For additional security information, contact [support@gentuity.com](mailto:support@gentuity.com) to request the Manufacturer Disclosure Statement for Medical Device Security (MDS2) document.

### Gentuity Security Controls

The Gentuity High-Frequency OCT Imaging System includes the following primary security controls:

- **System Hardening:** The system is configured to operate in an embedded kiosk mode to restrict access to the underlying operating system.
- **Access Control:** The system provides user authentication controls to prevent unintended access to data and configuration settings.
- **Anti-Malware:** The file system includes an active anti-malware program with updated anti-malware definitions.
- **Network Controls:** The system is configured to restrict unauthorized access, including a firewall configured to allow only the minimum required inbound and outbound traffic.
- **Encryption:** Patient data saved on the file system is encrypted using standard AES256 symmetric encryption. The system includes configurable options for Transport Layer Security (TLS) encryption for patient data transmitted over the network.
- **Peripheral Devices:** The system is configured to limit connection to allowed device types and USB mass storage access can be password protected.



## Gentuity Recommended Security Practices

Gentuity recommends the following security practices:

- Administrator and User Passwords: Gentuity recommends the system is initially set up with Administrator and User passwords that meet the local hospital IT password requirements.
- TLS Encryption and Network: Gentuity recommends protecting server configuration settings with the Administrator password and using TLS encryption for data exported via network.
- USB Drive Access: Gentuity recommends configuring USB drive access to require the Administrator password.
- Log Off Timer: Gentuity recommends configuring the log off timer to meet the local hospital IT requirements.
- Physical Storage: Gentuity recommends that the system is physically stored in an access-controlled environment.
- USB Management: Gentuity recommends using USB drives only with trusted computers running anti-malware software. For additional protection of patient information, use a USB drive with hardware encryption and restrict access to the USB drive by requiring a password.

## Software Information

To view the full list of commercial and open source off-the-shelf software used in this device, see **System Information** in **Maintenance** settings (described in Table 4-4 on page 4-17).

## Cybersecurity-Related Cautions

---

### CAUTIONS!

- If you believe that your system has been compromised by a cybersecurity breach, stop using the system and contact Genuity immediately at [support@genuity.com](mailto:support@genuity.com).
  - To minimize the risk of cybersecurity threats, only use USB drives with trusted computers running anti-virus and anti-malware software.
  - To prevent unauthorized access, do not use a password that can be easily guessed. Use a combination of letters, numbers, and symbols when creating a password.
  - Passwords are encrypted and cannot be recovered once they are set. If necessary, contact Genuity Support to help reset the password.
  - Genuity makes no representation or warranty that use of the Genuity High-Frequency OCT Imaging System complies with applicable privacy, security and confidentiality laws, but encourages you to assess your own risk as you use, disclose, control, process or transfer patient health information with the Genuity High-Frequency OCT Imaging System.
  - Do not use personally identifiable information in annotations. Annotations do NOT get anonymized.
  - Deleting a patient record deletes all pullback data for that patient, and cannot be recovered.
  - To help protect the system from unauthorized access, Genuity strongly recommends the use of the lock screen feature.
-

# Chapter 3

## System Overview

This chapter provides an overview of the Genuity High-Frequency OCT Imaging System. It includes information about its features, the components that are included in the system, the input and output connections on the system, the Probe Interface Module (PIM), and the Imaging Catheter.

---

### Overview

The Genuity High-Frequency OCT Imaging System is an intravascular Optical Coherence Tomography (OCT) imaging system. It uses near-infrared light to create high-resolution, in vivo images of coronary arteries.

---

---

**WARNING!** Medical personnel who use the Genuity High-Frequency OCT Imaging System must be aware of the system's limitations. Only trained operators can determine if the use of the Genuity High-Frequency OCT Imaging System is appropriate.

---

---

## System Components

The Genuity High-Frequency OCT Imaging System consists of the following components, as shown in Figure 3-1. Table 3-1 lists and describes the components.

**Figure 3-1 Genuity High-Frequency OCT Imaging System Components**

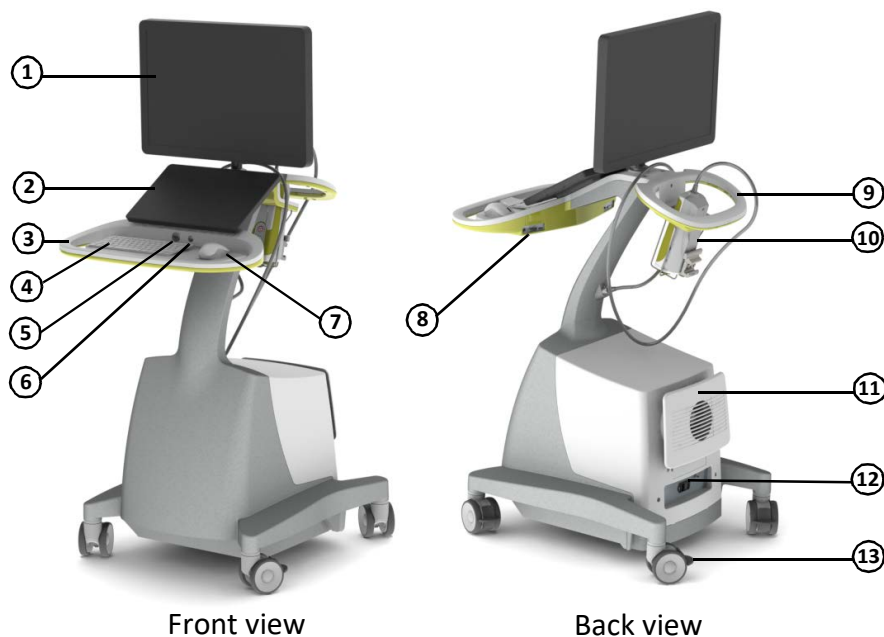

**Table 3-1 Genuity High-Frequency OCT Imaging System Components**

Item	Name	Description
1	Display Monitor (24 in) (Physician Side)	Primary image display for sterile operators (SO). Permits monitor tilt ( $-3^{\circ} \pm 90^{\circ}$ ) adjustment, and swivel ( $\pm 270^{\circ}$ ), as well as monitor removal for transport and shipment.
2	Touchscreen (15.6 in) (Operator Side)	Primary image and interface display for the Non-Sterile Operator (NSO).
3	Front handle	Integrated front and rear handles for transporting the system and for table-side positioning.
4	Keyboard	A standard keyboard used for data entry.
5	USB port	Located above the keyboard/mouse tray on the front of the system, used for exporting patient data from the system (archives, images, pullbacks, and so on) and storing the data on a USB drive. For details on supported USB drives, see “Restricting Access to USB Drive” on page 9-2.
6	On/Shut Down button	Located above the keyboard/mouse tray on the front of the system, used to turn the system on or shut down the system. For details, see “Connecting and Powering On the System” on page 4-1.

**Table 3-1 Genuity High-Frequency OCT Imaging System Components (Continued)**

Item	Name	Description
7	Mouse	Alternative pointing and selecting device.
8	Input/Output connections	Located on each side of the back of the keyboard/mouse tray, provides connection ports. For details, see “Input/Output Connections” on page 3-4.
9	Rear handle	Integrated front and rear handles for transporting the system and for table-side positioning.
10	Probe Interface Module (PIM) and PIM Cradle	<p>Bedside connection to catheter. Contains the bed rail mount, Start/Stop buttons, catheter pullback drive, and catheter rotation drive.</p> <p><b>CAUTION:</b> When not in use, always store the PIM in the PIM cradle with the PIM connector cover facing down.</p>
11	Cord wrap	AC power cable storage location for transport.
12	Power switch	Located on the lower back panel of the system, used to turn the main power to the system on and off.
13	Caster with brake	High-quality medical casters for mobile transport, fine positioning, and wheel locks.

---

**CAUTION!** The system components are integral parts of the Genuity High-Frequency OCT Imaging System. The Genuity High-Frequency OCT Imaging System hardware and software must not be modified in any way by the user. Making such modifications may interfere with correct operation and will void system warranties. Contact Genuity Support for more information.

---

## Input/Output Connections

The Input/Output (I/O) connections are located on both sides of the back of the keyboard/ mouse tray. As you face the touchscreen, the Ethernet and video input and output connections are on the right side, as shown in Figure 3-2.

**Figure 3-2 I/O Connections (Ethernet and External Video Input/Output)**

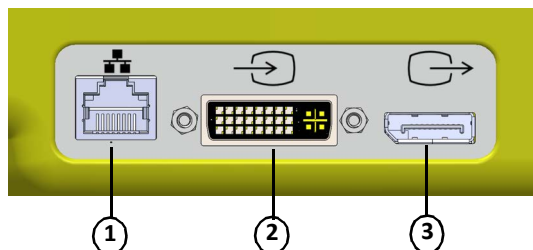
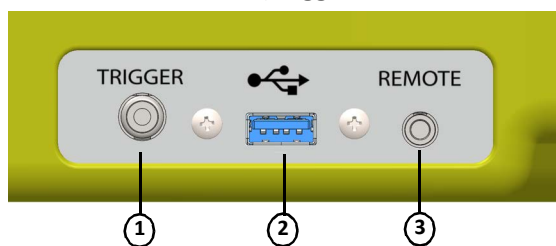

**Table 3-2 I/O Connections (Ethernet and External Video Input/Output)**

Item	Name	Description
1	Ethernet port	Ethernet cable connector for transfer of DICOM files from the Genuity High-Frequency OCT Imaging System to the hospital network server.
2	External video input	Input connector from angiography system to be displayed on the Genuity High-Frequency OCT Imaging System console.
3	External video output	Output connector for display of the Genuity High-Frequency OCT Imaging System image on an external monitor.

As you face the touchscreen, the trigger, USB port, and remote connections are on the left side, as shown in Figure 3-3.

**Figure 3-3 I/O Connections (Trigger, USB, and Remote)**



**Table 3-3 I/O Connections (Trigger, USB, and Remote)**

Item	Name	Description
1	Trigger	This feature is not available in this release.
2	USB port	Input for USB drives.
3	Remote	This feature is not available in this release.

---

## Probe Interface Module (PIM)

The PIM provides both automated rotation and longitudinal pullback of the imaging core within the Imaging Catheter. The PIM is rail-mountable and can be placed outside of the sterile field so that a Non-Sterile Operator (NSO) can connect the catheter to the PIM and operate it during the procedure.

The Imaging Catheter connects to the Genuity High-Frequency OCT Imaging System through the PIM. All imaging core rotation and translational pullback is driven by the PIM and occurs inside the catheter sheath.

Rotational speeds of the imaging core in the catheter range from 0 to 250 revolutions per second (rps). 100 rps (Preview mode) is possible and pullback imaging is conducted at 250 rps.

---

**CAUTION!** When not in use, always store the PIM in the PIM cradle with the PIM connector cover facing down.

---

**Figure 3-4 PIM**

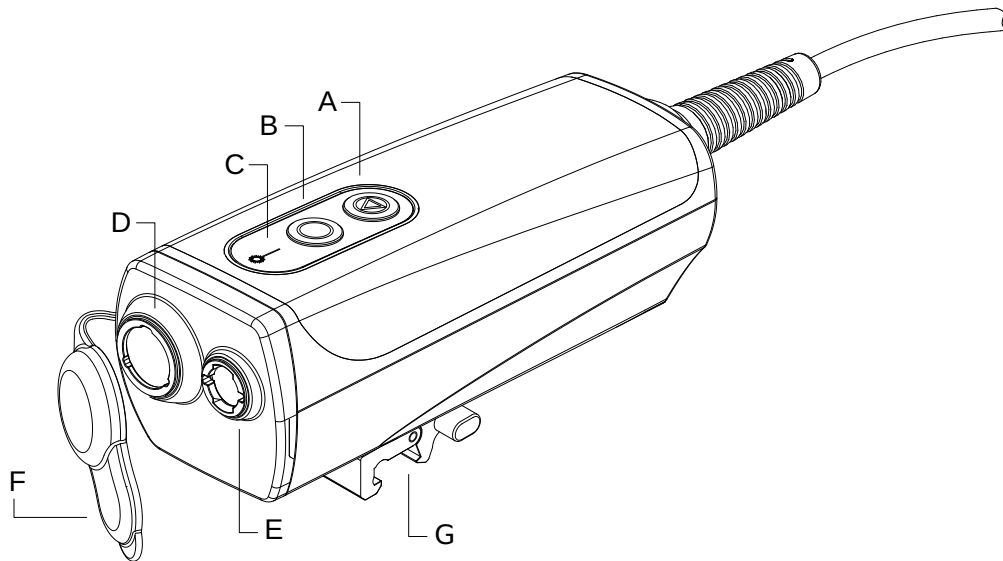

**Table 3-4 PIM Components**

Item	Name	Description
A	<b>STOP</b> button (red)	When pressed, stops the pullback and imaging rotation and turns off the laser output.
B	<b>GO</b> button (green)	When illuminated, pressing this button progresses to the next stage of the image acquisition: <ul style="list-style-type: none"> <li>• If the catheter is connected but the PIM is stopped or in Preview mode, Enables the system.</li> <li>• If the system is Enabled, pressing this button initiates the pullback.</li> </ul>
C	Laser Emission Symbol	Illuminated when laser output is on.
D	Optical Connection Port	Optical connection between the catheter and the PIM.
E	Pullback Connection Port	Pullback connection between the catheter and the PIM.
F	Connector Cover	Protects the optical and pullback connection ports from dirt and damage when not in use. <b>CAUTIONS!</b> <ul style="list-style-type: none"> <li>• When there is no catheter connected to the PIM, be sure the PIM connector cover is securely in place to protect from dirt and damage</li> <li>• When not in use, always store the PIM in the PIM cradle with the PIM connector cover facing down.</li> <li>• Protect the PIM connection ports and catheter connectors from fluids.</li> <li>• Do not touch the internal optics of the optical connector on the catheter or on the PIM.</li> </ul>
G	Rail Clamp	Provides the ability to clamp the PIM to the catheter table rail. <ul style="list-style-type: none"> <li>• To secure clamp to rail, hook the top of the clamp onto the rail and tilt downward.</li> <li>• To rotate the PIM as needed, push the PIM in and rotate the PIM body.</li> <li>• To disconnect the PIM rail clamp, squeeze the lever at the bottom of the clamp and lift upwards.</li> </ul> <p>The rail clamp is compatible with all major catheter table rails.</p>

---

## Catheter

The Genuity High-Frequency OCT Imaging System can only be used with compatible Vis-Rx Micro-Imaging catheters. For detailed information, refer to the *Instructions for Use* provided with the Imaging Catheter.



# Chapter 4

## System Setup

This chapter provides information and instructions for positioning the Genuity High-Frequency OCT Imaging System, connecting and powering on the system, shutting down the system, setting up the monitor(s), and configuring system settings.

---

### Positioning the System

Use the following guidelines when positioning the system:

- Position the Genuity High-Frequency OCT Imaging System at the foot of the patient table with the display monitor facing the sterile operator. The Genuity High-Frequency OCT Imaging System may be placed at other locations, however care must be taken to ensure the system is clear of any moving equipment, including the angiography system. It is the responsibility of the attending physician to ensure that collisions do not occur.
- Ensure that the physician is able to see and confirm information displayed on the system.
- Ensure the power cord and any other connections to the Genuity High-Frequency OCT Imaging System are routed to prevent a tripping hazard.
- Ensure that the main power switch and power plug are accessible at all times during the procedure.

---

### Connecting and Powering On the System

Make sure the power cord is connected to the system and is plugged into a grounded electrical outlet. For detailed information on electrical requirements, see “Making Proper Electrical Connections” on page 2-7.

➤ **To connect and power on the system:**

1. Connect the power cord to the power connection on the lower back of the system. The power cord will click into place.
2. Connect the other end to a hospital grade outlet.
3. If necessary, toggle the main power switch at the base of the cart to the ON position to turn on system power.
4. If necessary, press the On/Shut Down button located above the keyboard tray to start the system. The **Patient List** or **Log On** screen is displayed.

---

## Logging Onto the System

If your system is configured to require a password upon login, the **Log On** window is displayed prompting you to enter the password, as shown in Figure 4-1.

**Figure 4-1 Log On Window**

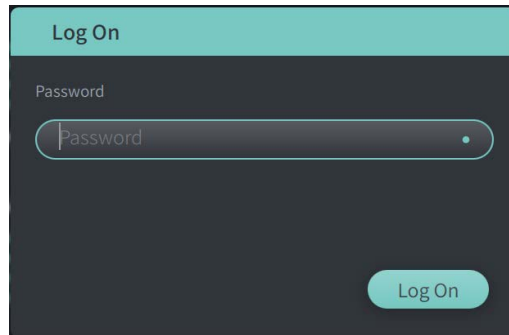

➤ **To log onto the system:**

1. Enter the password.
2. Select **Log On**. The **Patient List** is displayed. For more information, see “Patient Records” on page 5-1.

---

**Note** — For details on configuring a log on password, see “Configuring General Settings” on page 4-10.

---

---

## Logging Out of the System

### ➤ To log out of the system:

1. Select the **Shut Down** button  located at the top left corner of the screen. The **Shut Down Options** window is displayed, as shown in Figure 4-2.

**Figure 4-2 Shut Down Options Window**

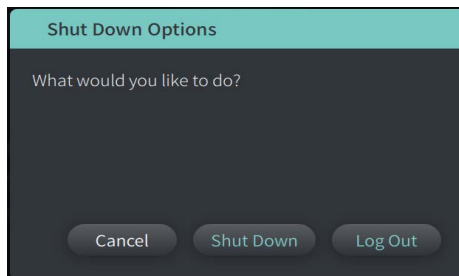

2. Select **Log Out**.

---

**Note** — The **Log Out** button is only displayed if the **User Password** is configured as **Required for Log On**. For more information, see “Configuring General Settings” on page 4-10.

---



---

## Shutting Down the System

There are two methods to shut down the Genuity High-Frequency OCT Imaging System:

- By pushing the On/Shut Down button on the front of the system above the keyboard tray.
- By selecting the Shut Down button on the touchscreen: 

### ➤ To shut down the system using the On/Shut Down button:

1. Press the **On/Shut Down** button on the front of the system, above the keyboard tray. The system shuts down immediately.

### ➤ To shut down the system using the touchscreen Shut Down button:

1. Select the **Shut Down** button  located at the top left corner of the screen. The **Shut Down Options** window is displayed, as shown in Figure 4-2 above.
2. Do one of the following:
  - To shut down the system, select **Shut Down**.
  - To log out of the current session, but keep the system powered on, select **Log Out**.
  - To continue using the system, select **Cancel**.

---

**Note** — The **Log Out** button is only displayed if the **User Password** is configured as **Required for Log On**. For more information, see “Configuring General Settings” on page 4-10.

---

---

## Setting Up the Monitor

This section provides instructions for adjusting positions of the Genuity High-Frequency OCT Imaging System display monitor, connecting an external monitor, and connecting video input from an angiography system.

### Setting Display Monitor Positions

You can adjust the angle and tilt of the display monitor (Physician side monitor). You cannot adjust the position of the touchscreen (Operator) monitor.

➤ **To adjust the display monitor position:**

1. Grasp the monitor firmly with one hand on each side of the screen.
2. Rotate the monitor as needed.
3. Adjust the viewing angle by tilting the monitor.

### Connecting an External Monitor

You can connect an external monitor to the Genuity High-Frequency OCT Imaging System through the video output on the I/O Panel (Figure 4-3) on the right back side of the system's keyboard/mouse tray (as you face the touchscreen). When connected, the monitor duplicates the display of the Physician side monitor.

**Figure 4-3 Video Output Connection**



➤ **To connect an external monitor:**

1. Connect the external monitor's cable to the port highlighted in Figure 4-3.
2. Make sure the external monitor is plugged in and powered on.

## Connecting Video Input from an Angiography System

The Genuity High-Frequency OCT Imaging System may be connected to an external angiography system using its video input cable.

---

**CAUTION!** The Genuity High-Frequency OCT Imaging System can only be connected to angiography systems that have been set up by Genuity Support.

---

You can connect the angiography monitor cable to the Genuity High-Frequency OCT Imaging System through the video input connector on the I/O panel (Figure 4-4) located on the back right side of the system's keyboard/mouse tray. When connected, the current angio image displays during live imaging and is captured during pullback acquisition.

When connecting the cable from the angiography system, note the following:

- Align the connector *before* seating to avoid damaging the connectors.
- Ensure all connectors are properly seated and fully tighten the thumb screws.

**Figure 4-4 Angiography Monitor Input Connection**

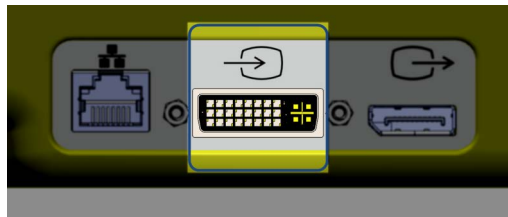

➤ **To connect an angio monitor:**

1. Connect the angiography monitor's cable to the port highlighted in Figure 4-4.
2. Make sure the angiography monitor is plugged in and powered on.

---

## Selecting the Procedure Room

The **Procedure Room** information is configured by Gentuity Support during the system installation.

If more than one room is configured for use for the system, you are prompted to select the room after pressing the  button. If only one room is configured for use, you do not need to select or specify the room information.

➤ **To select the Procedure Room:**

1. After entering a new patient record, or opening an existing patient record, select .
2. In the left lower corner of the screen, tap the **Procedure Room** drop-down and select the room.

**Figure 4-5 Selecting the Procedure Room**

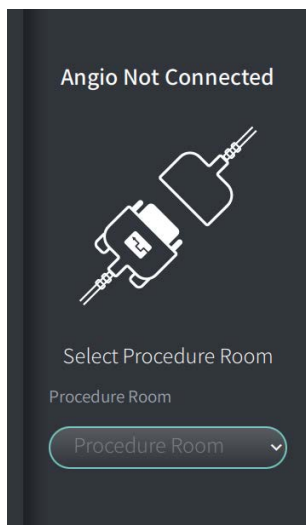

3. If the angio monitor is not yet connected, follow the instructions in “Connecting Video Input from an Angiography System” on page 4-5.

Once connected, the current angio image displays on the monitor during live imaging, and is captured during pullback acquisition.

---

## Preparing the PIM

➤ **To prepare the PIM:**

1. Remove the PIM from its cradle on the back of the system.
- 

### **CAUTIONS!**

- When there is no catheter connected to the PIM, be sure the PIM connector cover is securely in place to protect from dirt and damage
  - When not in use, always store the PIM in the PIM cradle with the PIM connector cover facing down.
  - Protect the PIM connection ports and catheter connectors from fluids.
  - Do not touch the internal optics of the optical connector on the catheter or on the PIM.
- 

2. Attach the PIM to the surgical bed rail.
  - To secure clamp to rail, hook the top of the clamp onto the rail and tilt downward.
  - To rotate the PIM as needed, push the PIM in and rotate the PIM body.

---

## Configuring System Settings

Use the **Settings** screen, shown in Figure 4-6, to configure the following types of settings in the Genuity High-Frequency OCT Imaging System:

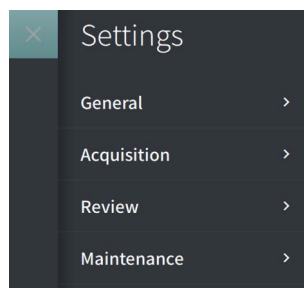

- **General Settings** to:
  - Set the date, time, time zone, and date format
  - Enter and configure hospital information including name, address, and logo
  - Enter, edit, or delete physician names
  - View the system’s storage capacity
  - Access Training Mode
  - Configure the log off timer
  - Specify what information is required when entering patient record data
- **Acquisition Settings** to:
  - Specify the types of flush media that can be used with the system
  - Set the default flush media
  - Show or hide the Repurge Reminder during acquisition
- **Review Settings** to select the color map
- **Maintenance Settings** to:
  - Back up data
  - Export software logs
  - View System Information (third party attribution information (Open Source Software Notices), and to export the Software Bill of Materials (SBOM) to a USB drive)
  - View Network Adapter Information
  - Add, edit, and test Network Export Server(s)

**Figure 4-6 Settings Screen**





➤ **To access the Settings screen:**

1. Select the **Settings**  icon to open the **Settings** screen.
2. Use the  icon to expand (view) settings. Use the  icon to collapse (hide) settings.
3. Configure the following settings as needed:
  - **General**
  - **Acquisition**
  - **Review**
  - **Maintenance**

## About the Administrator Password

To prevent unintended changes, some settings can be protected by an Administrator password. When the Administrator password is configured, the Administrator password must be entered to:

- Change or disable the log off time
- Change or disable the user password
- Change the required patient information in the **General** settings
- Change the available and default flush media settings in the **Acquisition** settings
- Restrict USB drive access in **General** settings
- Configure Network Export Servers in **Maintenance** settings

If the Administrator password is not configured, these settings are available to all users.

---

### CAUTIONS!

- Passwords are encrypted and cannot be recovered once they are set. If necessary, contact Genuity Support to help reset the password.
  - To prevent unauthorized access, do not use a password that can be easily guessed. Use a combination of letters, numbers, and symbols when creating a password.
- 

➤ **To configure the Administrator password:**

1. In the relevant settings section, select **Configure** to open the **Configure Administrator Password** window.

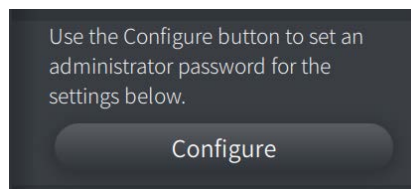

2. Select **Administrator Password Required** to indicate that a password is required to access the settings.
3. Enter the **Administrator Password** and reenter the password in the **Confirm Password** field.
4. Select **Save**.

## Configuring General Settings

Figure 4-7 shows the **General** section of the **Settings** screen and Table 4-1 lists and describes the **General** settings that you can configure.

➤ **To access the General settings:**

1. Select the **Settings**  icon to open the **Settings** screen.
2. Select **General**.



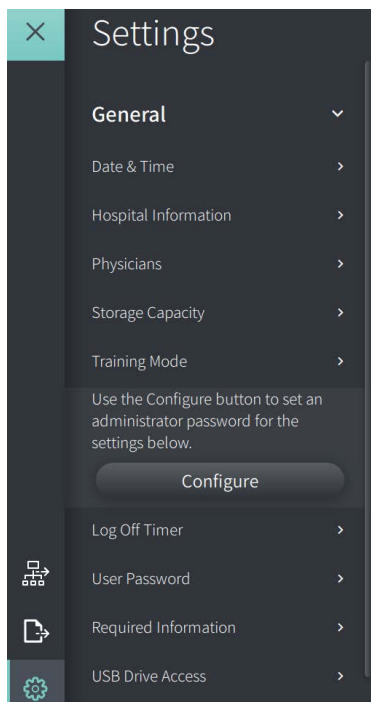

**Figure 4-7 General Settings Screen**





**Table 4-1 General Settings**

Setting	Description	How to Use
<b>Date &amp; Time</b>	Set the current date and time, and the time zone	<ol style="list-style-type: none"> <li>1. Select the day, month, and year in the <b>Today's Date</b> field.</li> <li>2. Select the <b>+</b> and <b>-</b> icons to set the time in 24-hour format. <b>Note:</b> You can also enter the time directly using the keyboard.</li> <li>3. Select the <b>Time Zone</b> for where the system is located.</li> <li>4. Select the <b>Date Format</b> using the examples displayed.</li> </ol>

Table 4-1 General Settings (Continued)

Setting	Description	How to Use
<b>Hospital Information</b> (for use in Report exports)	Hospital Name	Enter the name of the hospital.
	Hospital Address	Enter the address of the hospital.
	Hospital Logo image (the logo image must be in .png format)  If no image is added or the logo is deleted, the Hospital Logo report section is blank.	<p><b>To upload a hospital logo:</b></p> <ol style="list-style-type: none"> <li>1. Make sure a USB drive is inserted into one of the USB ports on the system and that the USB drive contains the logo image in .png format that you want to use.</li> <li>2. Select <b>Upload</b> and navigate to where the logo image is stored.</li> <li>3. Select the image.</li> </ol> <p><b>To replace the hospital logo or delete it:</b></p> <ul style="list-style-type: none"> <li>• To replace an existing logo, select <b>Replace</b> and follow steps 1-3 above to upload a new logo.</li> <li>• To remove the logo, select <b>Delete</b> and confirm the deletion.</li> </ul>
<b>Physicians</b>	Add and edit physician names in the system.	<p>Enter the name of the physician and select the  icon. To edit the physician's name, tap the name and edit the text as needed.</p> <p>To delete a physician's name, tap the  icon to the right of the physician's name. The physician's name will no longer appear in the drop-down list of physicians. To enter the physician's name in the patient record, see "Opening a Patient Record" on page 5-5.</p>
<b>Storage Capacity</b>	Displays the percentage of storage capacity used.	<b>Note:</b> You can free up storage space by archiving cases and deleting them from the system. For more information, see "Exporting Patient Records and Pullbacks" on page 9-1.
<b>Training Mode</b>	Lets you switch from Clinical Mode (live imaging) to Training Mode.  When selected, you can perform simulated procedures, review images, enter new patients, perform measurements, and so on, without the need to connect a catheter. The catheter and PIM are not activated during Training Mode.	<p>To access Training Mode, select <b>Switch to Training Mode</b>.</p> <p>To return to Clinical Mode:</p> <ol style="list-style-type: none"> <li>1. Shut down the system (see "Shutting Down the System" on page 4-3).</li> <li>2. Restart the system (see "Connecting and Powering On the System" on page 4-1).</li> <li>3. The system starts in Clinical Mode (live imaging) by default.</li> </ol>
<b>Log Off Timer</b>	The amount of inactivity time after which the system will log the user off. You can configure the timer from 5 minutes to 2 hours.	<ol style="list-style-type: none"> <li>1. Select the  and  icons to increase and decrease the log off time. <b>Note:</b> You can also enter the time directly using the keyboard.</li> </ol> <p>The format is hh:mm:ss for hours, minutes, and seconds.</p>

**Table 4-1 General Settings (Continued)**

Setting	Description	How to Use
<b>User Password</b>	Use this setting to configure user password requirement and to set the user password.	<ol style="list-style-type: none"> <li>1. Select <b>Configure</b> to open the <b>Configure User Password</b> window.</li> <li>2. Select <b>Required for Log On</b> to indicate that a password is required to log on to the system.</li> <li>3. Enter the <b>User Password</b> and reenter the password in the <b>Confirm Password</b> field.</li> <li>4. Select <b>Save</b>.</li> </ol> <p><b>Note:</b> For details on setting the lock screen, see “Setting the Lock Screen” on page 4-13.</p>
<b>Required Information</b>	<p>Indicates the information that is required to save the patient record. Fields include: <b>Patient ID Number, Last Name, First Name, and Date of Birth</b></p> <p>When selected, an indicator  displays next to the field name in the <b>Add Patient</b> window to indicate that the user is required to enter that field to save the patient record. If a field is required and the user does not enter that information, they are prompted to enter content in the field before they can save the patient record and proceed to imaging.</p>	Select the check box for each field that is required when a user enters and saves new patient information. You must select at least one of the fields.
<b>USB Drive Access</b>	An extra layer of security to prevent unauthorized use of a USB drive. When configured, the user is notified that a password is required when USB is selected.	When configured, restricts access to the USB drive by requiring a password when exporting patient data, exporting logs, and importing a hospital logo. When configured, the Export icon (  ) is dimmed but accessible. For details, see “Restricting Access to USB Drive” on page 9-2.

## Setting the Lock Screen



---

**CAUTION!** To help protect the system from unauthorized access, Genuity strongly recommends the use of the lock screen feature.

---

For added security, you can configure the Genuity High-Frequency OCT Imaging System to use a lock screen for when a user may be away from the system for a short period of time.

➤ **To configure the lock screen:**

1. Select the **Settings**  icon to open the **Settings** screen.
2. Select **General**.
3. Enter the Administrator password (if required) and press **Enter** on the keyboard, or tap **Log On**. The **Log Off** and **Configure** buttons are displayed.
4. Select **User Password** and then select **Configure**.
5. Select **Required for Log On** and enter the User password.
6. Enter the password again in the **Confirm New Password** field.
7. Select **Save**.
8. Select  in the upper left of the screen to close the **Settings** screen.
9. Select .
10. In the **Shut Down Options** window, select **Log Out**.

## Configuring Acquisition Settings

Figure 4-8 shows the **Acquisition** section of the **Settings** screen and Table 4-2 lists and describes the **Acquisition** settings that you can configure.

➤ **To access the Acquisition settings:**

1. Select the **Settings**  icon to open the **Settings** screen.
2. Select **Acquisition**.

**Figure 4-8 Acquisition Settings Screen**

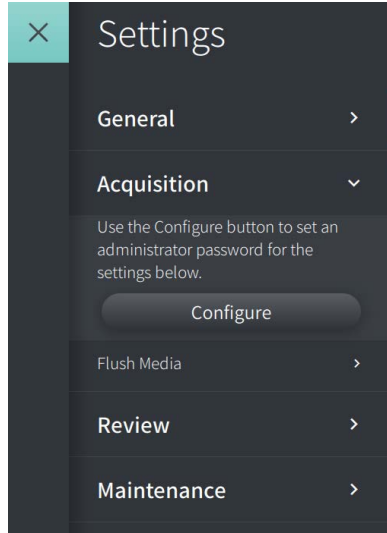

**Table 4-2 Acquisition Settings**

Setting	Description	How to Use
<b>Flush Media</b>	Lists the flush media and its associated ratio (if applicable) that can be used with the system.  Indicates which flush media is the default.	When selected, a check mark indicates that the flush media is available for use on the system during acquisition.  Select the default flush media by clicking the button to the left of the media. Only one flush media can be selected as the default.    The default flush media is used for each new patient. However, you can change to any of the other available choices as needed.

Table 4-2 Acquisition Settings (Continued)

Setting	Description	How to Use
<b>Repurge Reminder</b>	Lets you show and hide a repurge reminder during acquisition.	<p>When <b>Show Repurge Reminder</b> is selected, a reminder message is displayed during Preview or Enable to repurge the catheter, as shown in “Repurge Catheter” on page 6-8.</p> <p>When <b>Hide Purge Reminder</b> is selected, the repurge reminder message is not displayed during Preview or Enable.</p> 

---

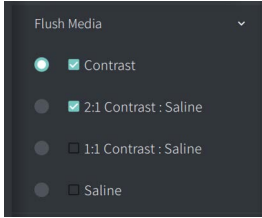
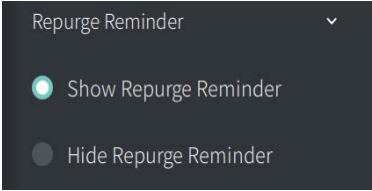

---

**WARNING!** Selecting the wrong flush media can cause measurement errors which could lead to incorrect treatment. Prior to acquisition, make sure the flush media identified in the **Pullback Settings** window matches the flush media you are using.

---



---

## Configuring Review Settings

Figure 4-9 shows the **Review** section of the **Settings** screen and Table 4-3 lists and describes the **Review** settings that you can configure.

➤ **To access the Review settings:**

1. Select the **Settings**  icon to open the **Settings** screen.
2. Select **Review**.

**Figure 4-9 Review Settings Screen**

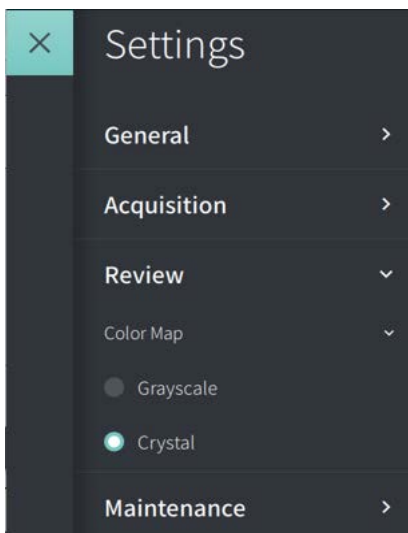

**Table 4-3 Review Settings**

Setting	Description	How to Use
<b>Color Map</b>	Lets you select the color map that is used to display the OCT image data	Select <b>Grayscale</b> or <b>Crystal</b> to change the color map. Genuity HF-OCT images use the Crystal color map by default, but certain applications may require a simple Grayscale color map.



## Configuring Maintenance Settings

Figure 4-10 shows the **Maintenance** section of the **Settings** screen and Table 4-4 lists and describes the **Maintenance** settings.

➤ **To access the Maintenance settings:**

1. Select the **Settings**  icon to open the **Settings** screen.
2. Select **Maintenance**.

**Figure 4-10 Maintenance Settings Screen**

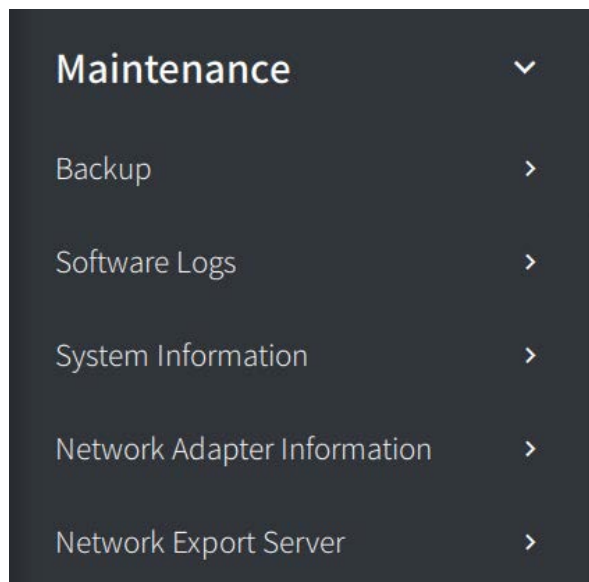

**Table 4-4 Maintenance Settings**

Setting	Description	How to Use
<b>Backup</b>	<b>Verify written data</b> slider control	Slide to <b>ON</b> to have the system check that all data was written properly as the final step of creating the backup.
	<b>Shut Down when complete</b> slider control	Slide to <b>ON</b> to shut down the system when the backup is complete
	<b>Backup all data</b> button creates a copy of all of the patient data that currently exists on the system onto a USB drive  <b>Note:</b> To minimize the time it takes to back up all data, Genuity recommends that you use a USB drive that meets the USB 3.0 or newer specification.	<ol style="list-style-type: none"> <li>1. Make sure a USB drive is inserted in the USB port.</li> <li>2. Select <b>Backup all data</b>.</li> <li>3. In the <b>Select a Directory</b> window, select the directory on the USB drive. If necessary, select <b>New Folder</b> and enter the name of the new folder.</li> <li>4. Select <b>Next</b>.</li> </ol>

**Table 4-4 Maintenance Settings (Continued)**

Setting	Description	How to Use
<b>Software Logs</b>	Software Logs are formatted for Genuity use only to help with troubleshooting. You can select the time frame for which logs to backup.	<ol style="list-style-type: none"> <li>1. Make sure a USB drive is inserted in the USB port.</li> <li>2. Select <b>Software Logs</b>.</li> <li>3. Select the time frame: <b>Today, Last 7 Days, Last 30 Days, or All Time</b>.</li> <li>4. Select <b>Export Logs</b>.</li> <li>5. In the <b>Select a Directory</b> window, select the directory on the USB drive. If necessary, select <b>New Folder</b> and enter the name of the new folder.</li> <li>6. Select <b>Next</b>. The logs are saved to the USB drive and a message with instructions to remove the drive is displayed when the log export is complete.</li> </ol>
<b>System Information</b>	Displays current software version, <b>Third Party Attribution</b> button, and <b>Export SBOM</b> button.	Refer to this software version when interacting with Genuity Support. Select <b>Third Party Attribution</b> button to view Open Source Software Notices. Select the <b>Export SBOM</b> button to export the Software Bill of Materials to a USB drive in CycloneDX format.
<b>Network Adapter Information</b>	Displays information about the console’s network adapter.	Information for hospital IT to reference when configuring the network export. This information includes the interface, MAC address, IP address, and Subnet mask.
<b>Network Export Server</b>	Displays information about the network servers that have been configured for DICOM export.	<p>Use this setting to add, edit, and configure hospital network servers to export patient data via a connected Ethernet cable.</p> <p>For details, see “Configuring Network Server Settings for Export” on page 9-3.</p>

---

**Note** — The **Backup** setting is not used to archive patient records. It is only for use in creating a backup that can be restored by Genuity Support in the event of an issue. For details on archiving patient records, see “Exporting Patient Records and Pullbacks” on page 9-1.

---

# Chapter 5

## Patient Records

This chapter provides information and instructions for accessing the **Patient List**, adding a patient record, and searching for, editing, and pinning patient records.

A patient record contains all pullbacks and image files obtained by the Genuity High-Frequency OCT Imaging System.

For details on exporting patient records, the export formats and options, and compatible devices to use for exporting, see “Exporting Patient Records and Pullbacks” on page 9-1.

### Accessing the Patient List

When you first turn on the system, the **Patient List** is displayed, as shown in Figure 5-1. Each patient record contains the patient’s HF-OCT images acquired from previous exams, if available, as well as the Patient ID Number. Table 5-1 lists and describes the parts of **Patient List** screen.

Figure 5-1 Patient List Screen

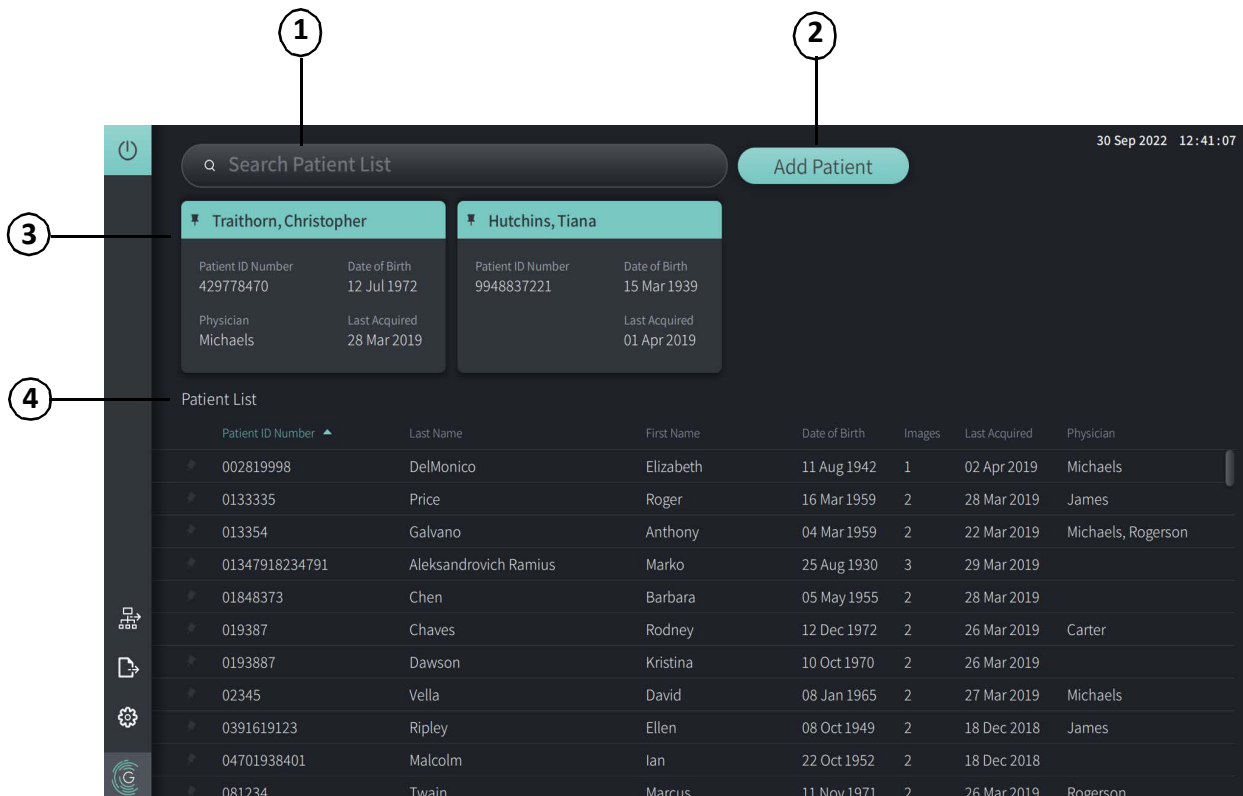

**Table 5-1 Patient List Screen**

Item	Description
1	<b>Search Patient List</b> (Use the search field to begin typing a patient’s name or the Patient ID Number)
2	<b>Add Patient</b> button
3	<b>Pinned Patient Records</b> section
4	<b>Patient List</b> section

## Adding a Patient Record

You can add a patient by typing the patient’s name or number in the search  field. If no matching patient record is found, a message is displayed, as shown in Figure 5-2.

**Figure 5-2 Patient Search**

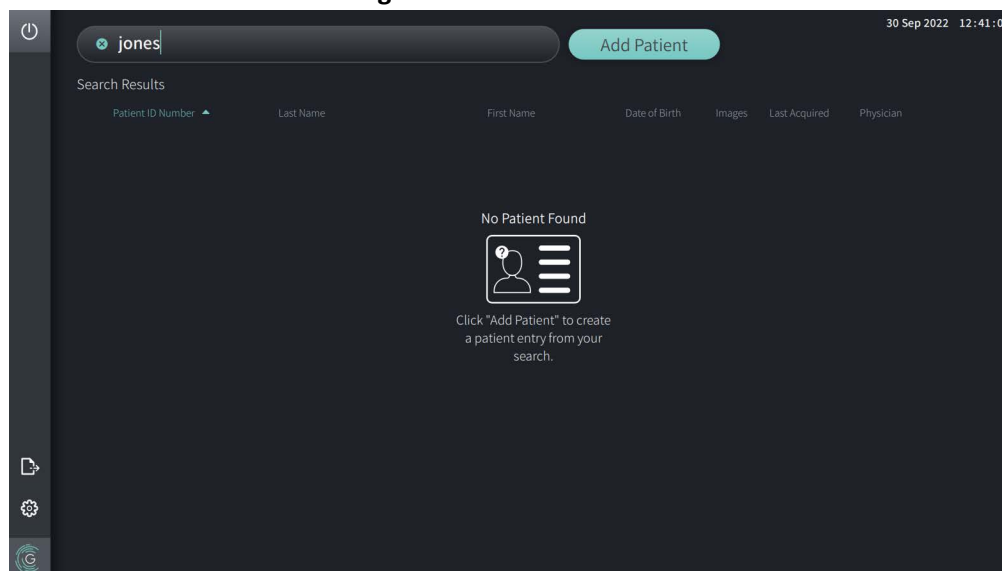

➤ **To add a patient record:**

1. Select **Add Patient**. The **Add Patient** window is displayed, as shown in Figure 5-3.
2. Enter the following information (fields with \* denote required information):

- **Patient ID Number**

- **Last Name**

- **First Name**

- Patient's **Date of Birth**. You can enter the date directly, or select the date by clicking or tapping  to display the drop-down options.

**Figure 5-3 Add Patient Window**

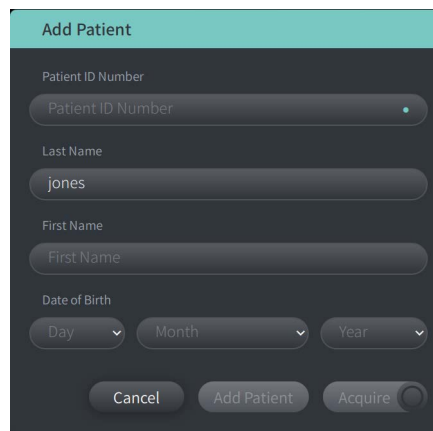

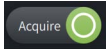
3. Do any of the following:
  - Select **Add Patient** to add the patient information to the database for later imaging. The patient record is automatically pinned in the **Patient List**. For details, see “Pinning a Patient Record” on page 5-7.
  - Select  to immediately start the patient exam.
  - Select **Cancel** to cancel adding the patient information.

## Searching for a Patient Record

Search for an existing patient record using either of the following methods:

- Using the search  field (**Search Patient List**)
- Sorting the columns in the **Patient List** to easily find a record

### Using the search field

Enter any identifying information about the patient record to locate the record in the database. For example, enter the patient's name, part of their name, their Patient ID Number, or other information to narrow the search. As you type, the system displays a list of items that match.

#### ➤ To use the search field:

1. Enter any identifying information about the patient in the search  field at the top of the screen.
2. If the patient record is found in the database, you can select the record from the **Patient List**.
3. If the patient record is not found, the system displays a message and prompts you to select the **Add Patient** button. For more information on adding a new patient record, see “Adding a Patient Record” on page 5-2.

### Sorting Patient List Columns





You can sort any of the columns in the **Patient List** to help find a patient record. The current sort order is indicated by a blue column heading and a  or  icon, as shown in Figure 5-4.

Figure 5-4 Patient List Sort Order

Patient ID Number 	Last Name	First Name	Date of Birth	Images	Last Acquired	Physician
002819998	DelMonico	Elizabeth	11 Aug 1942	1	02 Apr 2019	Michaels
0133335	Price	Roger	16 Mar 1959	2	28 Mar 2019	James
0133354	Galvano	Anthony	04 Mar 1959	2	22 Mar 2019	Michaels, Rogerson
01347918234791	Aleksandrovich Ramius	Marko	25 Aug 1930	3	29 Mar 2019	
01848373	Chen	Barbara	05 May 1955	2	28 Mar 2019	
019387	Chaves	Rodney	12 Dec 1972	2	26 Mar 2019	Carter
0193887	Dawson	Kristina	10 Oct 1970	2	26 Mar 2019	
02345	Vella	David	08 Jan 1965	2	27 Mar 2019	Michaels
0391619123	Ripley	Ellen	08 Oct 1949	2	18 Dec 2018	James
04701938401	Malcolm	Ian	22 Oct 1952	2	18 Dec 2018	
081234	Twain	Marcus	11 Nov 1971	2	26 Mar 2019	Rogerson

For example, you can sort the **Patient ID Number** column in ascending or descending order to find the patient, as shown above.

#### ➤ To sort the Patient List columns:

1. Select the column heading to sort the list by the information in the column. A blue heading indicates the current sort order of the list.
2. To switch from ascending or descending order, tap  or  or tap the column heading.

## Opening a Patient Record

Each patient record contains the patient's HF-OCT images acquired from previous exams, if available. The pullbacks are organized by date with the most recent exam listed first, as shown in Figure 5-5.

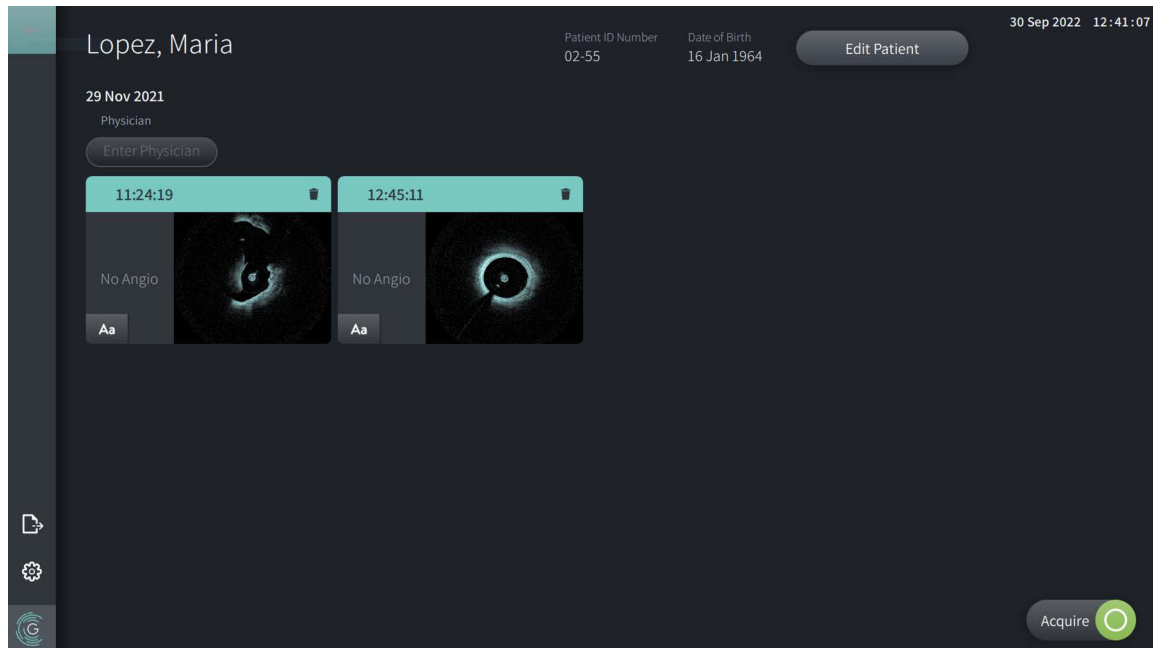
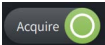

**Figure 5-5 Patient Record**



### ➤ To open a patient record:

1. Select the patient record from the **Patient List**. If necessary, use the search  field to locate the patient in the list, or sort the list by clicking a column heading to help locate the patient in the **Patient List**.
2. Do any of the following:
  - To review existing images, select the image from the patient records section.
  - To edit the patient's information, select **Edit Patient** in the upper section of the screen. See "Editing Patient Information" on page 5-6 for more information.
  - To edit/add the attending physician for the case, tap the **Enter Physician** button or the **Select Physician** button and type the name or choose the physician's name from the list.

**Note** — The list of physician's names can also be entered in the **Settings** screen. For more information, see "Configuring General Settings" on page 4-10.

- To acquire a new image for the current patient, select .
- To add a note to an existing image, tap  in the bottom panel of the pullback and enter the text for the note.

---

**CAUTION!** Do not use personally identifiable information in annotations. Annotations do NOT get anonymized.

---

- To delete a pullback image from the patient record, select the delete  icon and confirm the deletion.

---

## Editing Patient Information

Use the **Edit Patient** window to edit the patient's information or to delete a patient record.

**Figure 5-6 Edit Patient**

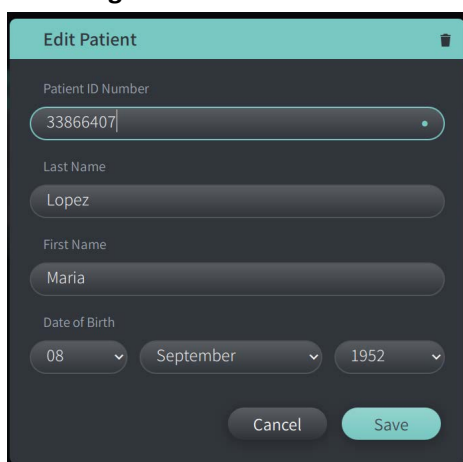

➤ **To edit a patient record:**

1. Select the patient record from the **Patient List** or from the pinned records section, if applicable.
2. Select the **Edit Patient** button.
3. Edit the patient's information as needed.
4. Do either of the following:
  - To save the changes, select **Save**.
  - To discard the changes, select **Cancel**.



➤ **To delete a patient record:**

**CAUTION!** Deleting a patient record deletes all pullback data for that patient, and cannot be recovered.

1. Select the patient record from the **Patient List** or from the pinned records section, if applicable.
2. Select the **Edit Patient** button.
3. To delete the patient record, select  in the upper right corner of the **Edit Patient** window, and confirm the deletion.
4. Do either of the following:
  - To delete the record, select **Delete**.
  - To discard the changes and keep the record, select **Cancel**.

## Pinning a Patient Record

Pinning a patient record lets you add it to the area above the **Patient List**, as shown in Figure 5-7. This is helpful for setting up the list of patients for the day, or keeping the patient record in view for easy reference. The highlighted pin icon  indicates that the patient record is pinned.

**Note** — When you initially add a new patient without acquiring, the patient record is automatically pinned.

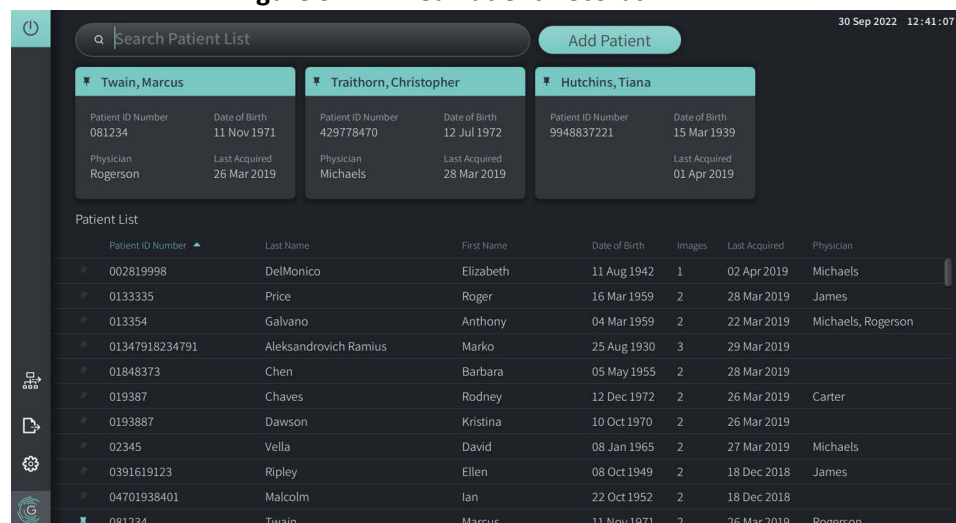

**Figure 5-7 Pinned Patient Records**



The screenshot shows a software interface for patient management. At the top, there is a search bar labeled 'Search Patient List' and an 'Add Patient' button. Below this, three patient records are displayed in a grid, each with a pin icon in the top left corner. The records are for Twain, Marcus; Traithorn, Christopher; and Hutchins, Tiana. Below the grid is a 'Patient List' table with columns for Patient ID Number, Last Name, First Name, Date of Birth, Images, Last Acquired, and Physician. The first row of the list is highlighted, and it corresponds to the first pinned record, Twain, Marcus.

Patient ID Number	Last Name	First Name	Date of Birth	Images	Last Acquired	Physician
002819998	DelMonico	Elizabeth	11 Aug 1942	1	02 Apr 2019	Michaels
0133335	Price	Roger	16 Mar 1959	2	28 Mar 2019	James
013354	Galvano	Anthony	04 Mar 1959	2	22 Mar 2019	Michaels, Rogerson
01347918234791	Aleksandrovich Ramius	Marko	25 Aug 1930	3	29 Mar 2019	
01848373	Chen	Barbara	05 May 1955	2	28 Mar 2019	
019387	Chaves	Rodney	12 Dec 1972	2	26 Mar 2019	Carter
0193887	Dawson	Kristina	10 Oct 1970	2	26 Mar 2019	
02345	Vella	David	08 Jan 1965	2	27 Mar 2019	Michaels
0391619123	Ripley	Ellen	08 Oct 1949	2	18 Dec 2018	James
04701938401	Malcolm	Ian	22 Oct 1952	2	18 Dec 2018	
081234	Twain	Marcus	11 Nov 1971	2	26 Mar 2019	Rogerson

➤ **To pin a patient record:**

1. Select the dark pin  icon to the left of the patient's ID number. The pin changes to green and the patient's record is displayed in the pinned records section.
2. To scroll through the pinned records, use your finger to swipe right and left, or use the mouse to drag right and left in the pinned records section.
3. To unpin a record, select the highlighted pin  or select the pin in the pinned records section. The patient record is removed from the pinned records section, but remains in the **Patient List**.

# Chapter 6

## Performing an HF-OCT Procedure

This chapter provides information and instructions for performing an HF-OCT procedure. It includes an overview of the procedure, the materials and equipment required for the procedure, and how to set up the system and prepare the PIM.

For detailed information and instructions on how to prepare and use the Imaging Catheter, refer to the *Instructions for Use* provided with the Imaging Catheter.

---

### Overview

The following summarizes the general steps to image using the Genuity High-Frequency OCT Imaging System:

1. Set up the system for imaging.
2. Enter or select the patient record.
3. Prepare the PIM and catheter.
4. Prepare flush media.
5. Insert and position the catheter.
6. Begin the acquisition sequence.
7. (Optional) Preview to confirm position of catheter within the vessel.
8. (Optional) Deliver approximately 5 ml of flush media to confirm alignment.
9. Enable the start of high-speed rotation.
10. Inject the flush media.
11. Acquire the pullback.
12. Confirm that the acquired images are acceptable.
13. Remove the catheter.

This chapter provides detailed instructions on each step.

The HF-OCT procedure requires two operators:

- **Sterile Operator (SO):** All steps that require contact with the Imaging Catheter must be performed by the sterile operator.
- **Non-Sterile Operator (NSO):** All steps that are performed in direct contact with the Genuity High-Frequency OCT Imaging System or the PIM are performed by the Non-Sterile Operator.

After the HF-OCT pullback has been recorded, it is immediately available for review. For more information, see “Reviewing HF-OCT Recordings” on page 7-1.

## Required Materials and Equipment

The following materials and equipment are required to perform the HF-OCT procedure:

- Genuity High-Frequency OCT Imaging System
- Vis-Rx Micro-Imaging Catheter
- 3 ml purge syringe (included with the Imaging Catheter)
- Contrast media indicated for coronary use, for flush (allow 15 ml for each pullback planned)
- .014" (0.36mm) guidewire (with torque device if desired)
- Guide catheter (6 French, 0.068" (1.73mm) ID or larger, with no side holes)
- Sheath introducer (to match guide catheter)
- Hemostatic Y-Adapter/Connector
- Heparinized saline for hydrophilic catheter preparation and catheter purging
- Power injector pump for coronary angiography or coronary control syringe (minimum 10 ml)

---

## Setting up the System

Setting up the system for performing an HF-OCT procedure includes the following steps:

1. Position the system for use as described in "Positioning the System" on page 4-1.
2. Turn the system on, as described in "Connecting and Powering On the System" on page 4-1.
3. Adjust the display monitor as needed, as described in "Setting Up the Monitor" on page 4-4.
4. Prepare the PIM, as described in "Preparing the PIM" on page 4-7.
5. Optionally, connect the angiography input, as described in "Connecting Video Input from an Angiography System" on page 4-5.
6. Optionally, connect to an external display monitor, as described in "Connecting an External Monitor" on page 4-4.

## Using the Imaging Catheter

**WARNING!** Prior to use and for more detailed information, refer to the *Instructions for Use* provided with the Imaging Catheter.

**Note** — The procedures in the following sections indicate who performs each step: Sterile Operator (**SO**) or Non-Sterile Operator (**NSO**).

### Connecting the Catheter to the PIM

The system provides illustrated instructions for connecting the catheter to the PIM, as shown in Figure 6-1.

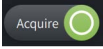
The instructions are displayed when you select the  button if the catheter is not yet connected to the PIM.

**Figure 6-1 Connecting Catheter to PIM**

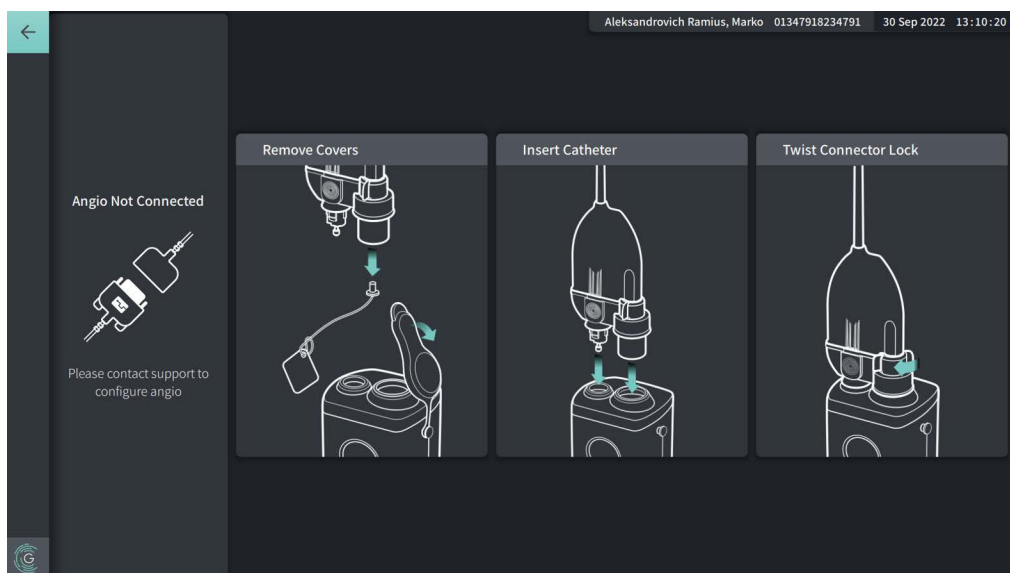

#### ➤ To connect the Imaging Catheter to the PIM:

1. **NSO:** Attach the PIM to the surgical bed rail.
  - To secure clamp to rail, hook the top of the clamp onto the rail and tilt downward.
  - To rotate the PIM as needed, push the PIM in and rotate the PIM body.
2. **NSO:** Carefully open the catheter and syringe pouches and transfer the contents into the sterile field using sterile techniques.
3. **SO:** Using sterile techniques, pass the catheter connector to the **NSO** near the PIM.
4. **NSO:** Remove the cover from the PIM connector and the cover from the catheter optical connector. (See Figure 6-1 for details)

5. **NSO:** Align the catheter connectors to the connection ports on the PIM and insert the catheter into the PIM until it snaps into place.
6. **NSO:** Rotate the optical connector clockwise to the LOCKED position.

---

---

### **WARNINGS!**

- Observe sterile technique when connecting the catheter to the PIM, which is outside of the sterile field.
  - Do not disconnect the Imaging Catheter from the PIM until the procedure is complete to avoid a potential sterility breach.
- 
- 

---

### **CAUTIONS!**

- Protect the PIM connection ports and the catheter connectors from fluids.
  - Do not touch the internal optics of the optical connector on the catheter or on the PIM.
- 

When properly connected, a red light is displayed at the lens of the catheter and the system progresses to the next stage of readiness.

## **Inserting and Positioning the Catheter**

For detailed information, refer to the *Instructions for Use* provided with the Imaging Catheter.

## **Confirming Imaging Settings**

This section provides instructions for confirming imaging settings.

When confirming imaging settings, you are prompted to select the **Pullback Settings**. **Pullback Settings** include:

- One Second Imaging™: 100mm, 1 second
- Survey: 100mm, 2 seconds
- Short Survey: 50mm, 1 second
- High Density: 50mm, 2 seconds

➤ **To confirm imaging settings:**

1. **NSO:** When ready, select  on the touchscreen. If the catheter has not yet been connected, the system provides user guidance, as shown in Figure 6-1 on page 6-3.

The **Imaging Settings** window is displayed, as shown in Figure 6-2.

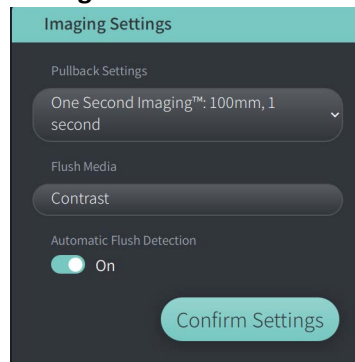

**Figure 6-2 Confirm Settings**



2. **NSO:** Specify the following settings in the **Imaging Settings** window:
  - Select the **Pullback Settings**, as described above.
  - Confirm the default **Flush Media** type or select another **Flush Media** type.
  - In the **Automatic Flush Detection** section, select **ON** (the default setting) for automatic detection, or **OFF** for manual detection.

---

**Notes**

- **Automatic Flush Detection (ON)** is the default setting in which the system triggers a pullback automatically when a brief sequence of clearing is detected as a result of contrast injection. If clearing is not detected within 15 seconds after being enabled, the system displays a Timeout error. You can initiate pullback manually when in Automatic mode by selecting  on the touchscreen or by pressing the **GO** button on the PIM.
  - **Automatic Flush Detection (OFF)** is the manual setting. After clearing is observed, select  on the touchscreen or press the **GO** button on the PIM to start the pullback. If you do not initiate the pullback within 15 seconds after the system is enabled, the system displays a Timeout error.
- 

3. **NSO:** Select **Confirm Settings** to continue.

## Preparing the Flush Media

---

---

### WARNINGS!

- Refer to the contrast media's instructions for general warnings and precautions relating to contrast media.
  - Selecting the wrong flush media can cause measurement errors which could lead to incorrect treatment. Prior to acquisition, make sure the flush media identified in the **Pullback Settings** window matches the flush media you are using.
  - Make sure to use the contrast media and injectors according to specifications given by the manufacturers. Excessive flow rate and pressure may damage the blood vessel or devices used with the catheter. Low flush rate may result in a faint image.
- 
- 

**Note** — The flush media source (injector or syringe) should be connected to the Y-connector on the guide catheter.

---

### ➤ To prepare the flush media:

1. **SO:** Depending on the type of flush media injection, do one of the following:
  - If using an **automated injector**, ensure the selected flush media is loaded in the injector and set the flush rate to 4 ml/sec or less, with a total volume of 16 ml or less and pressure limit of 300 psi (2068 kPa).
  - If using a **manual injection**, prepare a coronary control syringe capable of injecting up to 4 ml/sec for 3 to 4 seconds.



## Beginning Preview (Optional)

Perform the following *optional* steps in **Preview** to confirm the position of the catheter within the vessel.

**Figure 6-3 Imaging Settings-Preview**

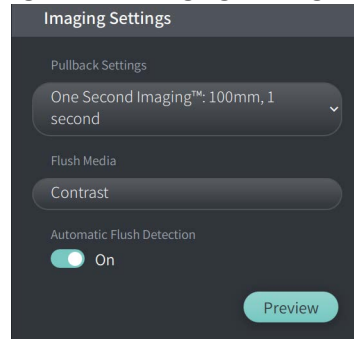

1. **NSO:** When the catheter is in position, select **Preview** (Figure 6-3). Upon selecting **Preview**, the PIM will activate and the HF-OCT image is displayed. A **Calibration** window (Figure 6-4) is also briefly displayed.

**Figure 6-4 Calibration window**

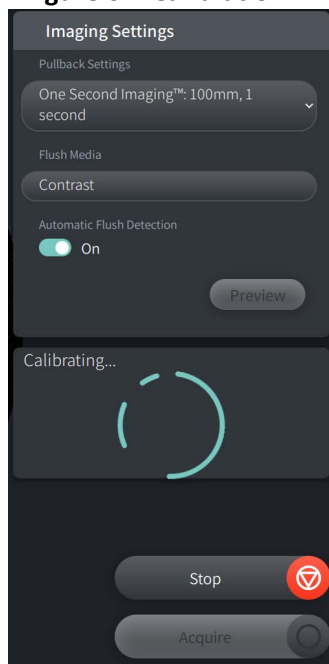

The **Repurge Catheter** reminder message is displayed (Figure 6-5). Note, the display of this reminder is configurable. For details, see “Configuring Acquisition Settings” on page 4-14.

**Figure 6-5 Repurge Catheter**

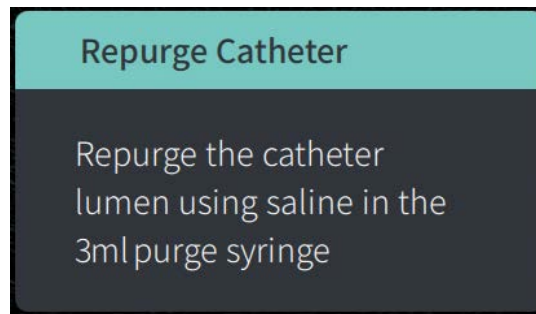

2. **SO:** If necessary, use the 3 ml purge syringe to eliminate any blood from the catheter lumen.

#### **Delivering 5 ml Flush Media to Confirm Alignment**

Optionally, you can deliver flush media to confirm alignment of the guide catheter with the vessel.

➤ **To deliver flush media and confirm alignment:**

1. **SO:** Deliver approximately 5 ml of flush media via the Y-connector to fill the guide catheter with the flush media and to ensure proper guide catheter alignment with the ostium under fluoroscopic guidance.

---

**CAUTIONS!**

- To help ensure successful imaging, the guide catheter should be oriented to preferentially direct the flush media flow to the target artery.
  - To help ensure successful imaging, do not use a guide catheter with side holes.
- 

2. Proceed to **Enable** step, or press **STOP** on the touchscreen (or on the PIM) to exit Preview mode.

## Enabling the Start of High-Speed Rotation

➤ **To enable the system to start high-speed rotation:**

1. **NSO:** With confirmation of proper guide position and Imaging Catheter position, select **ENABLE** on the Genuity High-Frequency OCT Imaging System touchscreen (or press the green **GO** button on the PIM) to start high-speed PIM rotation.

When the PIM reaches full speed and the catheter is calibrated, the system is ready for pullback. The 15-second clock begins, and the system prompts for injection of the flush media.

---

**Note** — If you do not inject the flush media and initiate pullback within 15 seconds, the PIM rotation stops completely and a Timeout window is displayed. Select **Okay** and then select **Enable** to enable the system when ready to image.

---

## Injecting Flush Media and Initiating Pullback

---



---

**WARNING!** Before injecting flush media, be sure that the hemostasis valve is tightened to reduce the risk of unintended catheter movement or leaking of flush media during injection.

---

---

➤ **To inject the flush media and initiate pullback:**

1. **SO:** Inject the flush media into the target artery via the Y-connector on the guide catheter.
2. **NSO:** Depending on the selected Automatic Flush Detection setting, do one of the following:
  - **Automatic Flush Detection (ON):** The system automatically initiates pullback when clearing is detected. Alternatively, you can manually initiate pullback prior to the automatic trigger by selecting  on the touchscreen or by pressing the green **GO** button on the PIM.
  - **Automatic Flush Detection (OFF):** Select  on the touchscreen or press the green **GO** button on the PIM to initiate pullback and start capturing images once the blood is removed and a clear image displays (1-2 seconds after injecting the flush media).

The image displays after completion of the pullback. The optical imaging core returns to the distal position within the sheath for further imaging.

---

**CAUTION!** If the optical imaging core encounters resistance while returning to the distal position within the sheath (due to a kink or blockage), the Advance Force Limiter will buckle to absorb the forward motion. If this occurs, carefully remove the Imaging Catheter from the guide catheter. Replace with a new catheter if further imaging is required.

---

### Notes

- **SO:** Do not remove the catheter until you confirm the image is acceptable.
  - **NSO:** Do not disconnect the catheter from the PIM until no more HF-OCT images are required.
-

---

## Removing the Catheter

For detailed information, refer to the *Instructions for Use* provided with the Imaging Catheter.

---

## Completing the Exam

---

**Note** — Images and all measurements and annotations are automatically saved with the patient record and are available when the record is reopened.

---

When the exam is complete, perform the following steps:

1. Shut down the system using the **Shut Down** button.
2. Before moving the system:
  - Release the PIM from the bed rail and place it in the PIM cradle on the Gentuity High-Frequency OCT Imaging System. The PIM must be placed in the cradle so that the connection ports are facing down.

---

### CAUTIONS!

- When there is no catheter connected to the PIM, be sure the PIM connector cover is securely in place to protect from dirt and damage.
  - When not in use, always store the PIM in the PIM cradle with the PIM connector cover facing down.
- 
- If necessary, disconnect the power cord from AC power.
  - Wrap the PIM cord around the rear handle so that it does not drag on the floor.
- 

**Note** — To save time powering up the system, it is recommended that you leave the power switch on the back of the system in the ON position when finished using the system.

---



# Chapter 7

## Reviewing HF-OCT Recordings

This chapter provides information and instructions for reviewing the HF-OCT recordings. It includes details about the Image screen used to view and review pullback images, and the view modes.

---

### Overview

Review mode is immediately available following a pullback.

When reviewing recordings, the default Image screen shows a 2D image of the pullback, the Lumen Profile display, and if connected, the angio image acquired during pullback. Lateral (L-Mode) and 3D views are also available.

---

#### Notes

- To optimize the view of the lumen/vessel and surrounding tissue, use the pinch and zoom gestures to zoom in and out of the 2D image. You can also use Ctrl+scroll wheel on the mouse to zoom in on an image and the Lumen Profile.
  - You can also size the panels in the Image screen to increase or reduce the size of the content in the panel.
-

## Image Screen

Use the Image screen to view the pullback images. Figure 7-1 shows the Image screen and its elements, and Table 7-1 lists and describes each item in the Image screen.

Figure 7-1 Image Screen

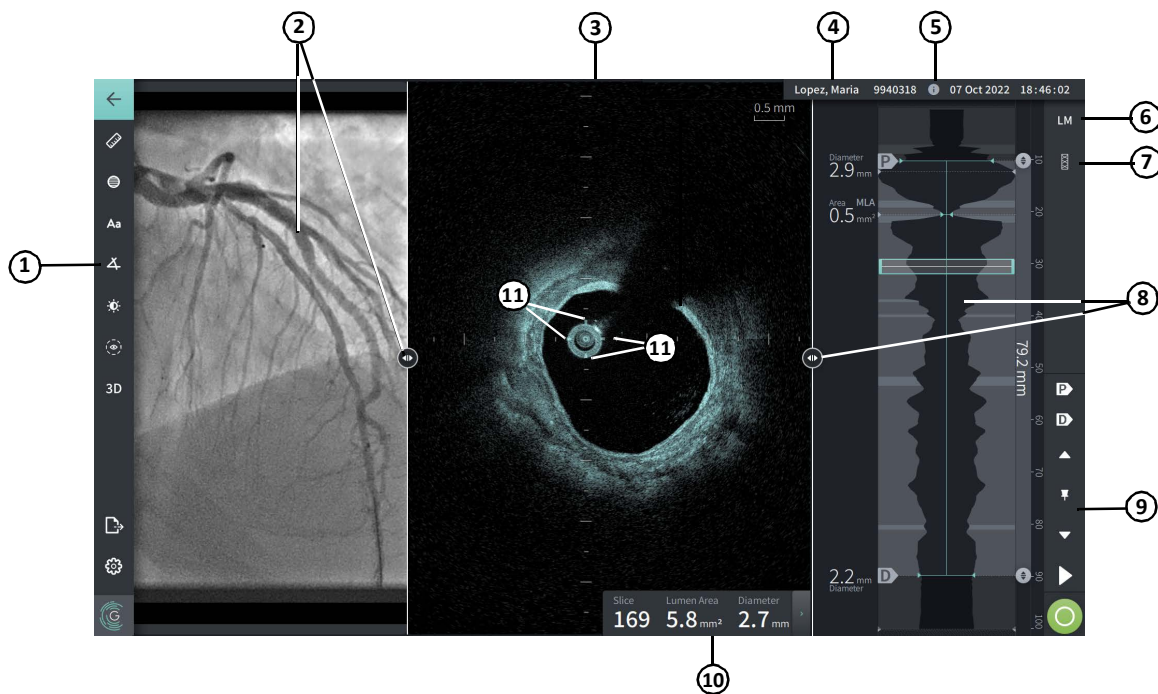

Table 7-1 Image Screen

Item	Name	Description	For more information, see:
1	Menu Bar	Provides an icon to return to the previous screen, tools for adding measurements, annotations, and adjusting the contrast and brightness, and access to the <b>Settings</b> window and Export functions.	“Menu Bar” on page 7-4
2	Angio Image Display and resizing tool	If connected during acquisition, this section displays the angiogram acquired at the time of pullback. Use the resizing tool to show, hide, and change the size of the angio image display.	“Angio View” on page 7-5
3	2D View and resizing tool	Displays a two-dimensional image of the vessel during playback. Use the resizing tool to show, hide, and change the size of the image.	“2D View” on page 7-6
4	Patient Information title bar	Displays the patient name, patient ID, and in the far right corner, the date and time of the pullback.	“Accessing the Patient List” on page 5-1



**Table 7-1 Image Screen (Continued)**

<b>Item</b>	<b>Name</b>	<b>Description</b>	<b>For more information, see:</b>
5	Pullback Information Icon	When clicked, opens the Pullback Information window to view details about the displayed pullback.	“Viewing Pullback Information” on page 7-22
6	L-Mode control	A control to view and hide the L-Mode.	“L-Mode” on page 7-19
7	Stent Expansion control	A control to turn on Stent Expansion mode.	“Stent Expansion” on page 7-16
8	Lumen Profile Display and resizing tool	Shows the relative size of the lumen area throughout the pullback. Use the resizing tool to show, hide, and change the size of the Lumen Profile display.	“Lumen Profile Display” on page 7-8
9	Playback Controls	Controls to playback the HF-OCT recording.	“Reference Markers and Playback Controls” on page 7-11
10	Current Slice Information Panel	Provides the slice number within the pullback and the automated lumen measurements on the displayed 2D image.	“Current Slice Information Panel” on page 7-7
11	Calibration Fiducials	The four lines around the catheter provide a visual indication of the expected catheter size when correctly calibrated.	--

## Menu Bar

The Menu Bar, shown in Figure 7-2, is located on the left side of screens in the Genuity High-Frequency OCT Imaging System during review. Table 7-2 lists and describes the elements of the Menu Bar.

**Figure 7-2 Menu Bar**



**Table 7-2 Menu Bar**

Item	Name	Description
1	Back icon	Returns to the previous screen
2	Linear measurement tool	Provides tools to add linear, longitudinal, area, and angle measurements and annotations to the image. You can also add longitudinal measurements on the Lumen Profile and L-Mode. For more information about the tools, see “Measurements and Annotations” on page 8-1.
3	Area measurement tool	
4	Annotation tool	
5	Angle Measurement tool	
6	Image Adjustment	Lets you adjust the contrast and brightness of the displayed image.
7	Lumen Trace icon	Lets you view and hide the Lumen Trace on the image.
8	3D control	A control to view the 3-dimensional image display. For details, see “3D View” on page 7-20.
9	Export icon	An icon to export patient records and pullback images to a USB drive. For more information about exporting patient records, see “Exporting Patient Records from the Patient List” on page 9-7.
10	Settings icon	Opens the <b>Settings</b> window to configure system settings. For more information, see “Configuring System Settings” on page 4-8.

## Angio View

If connected to an angiography system video output during acquisition, the left side of the Image screen displays the time-synchronized angiogram acquired at the time of pullback.

Use the resizing tool  to resize, expand, and collapse the Angio view.

For more information on connecting an angiography system video output, see “Connecting Video Input from an Angiography System” on page 4-5.

**Figure 7-3 Angiogram View**

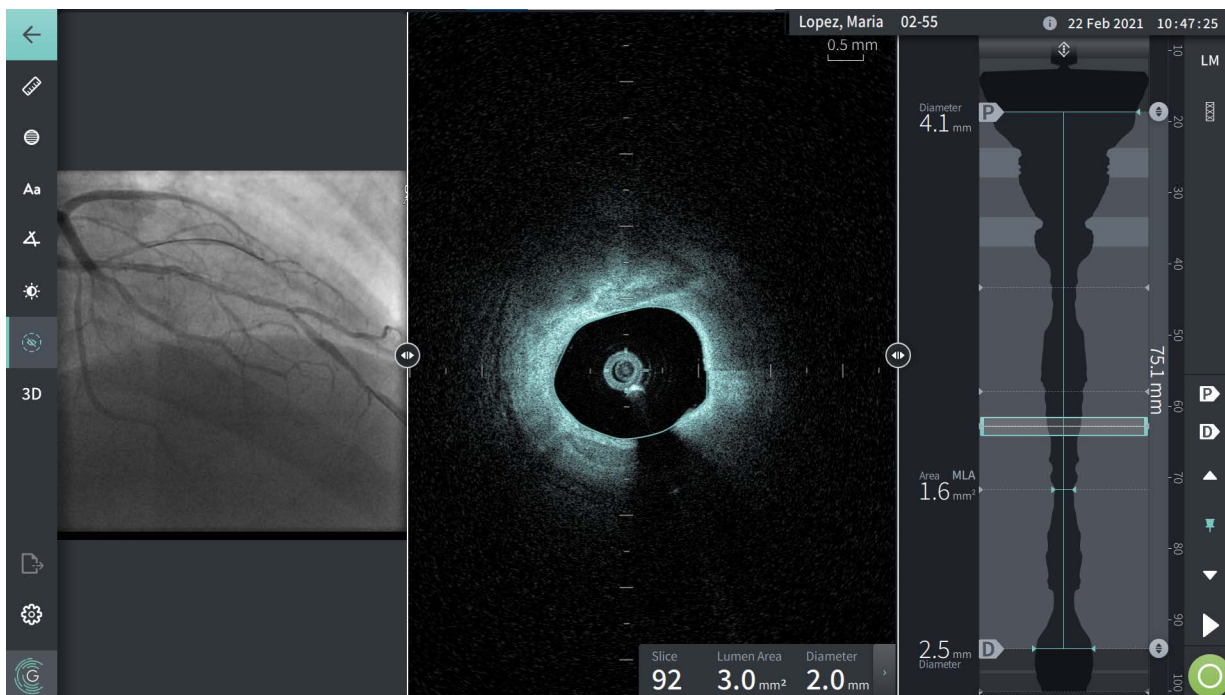

## 2D View

During the HF-OCT pullback recording, the system captures a 3-dimensional volume which is rendered into 2-dimensional slices, or cross-sections, for viewing.

In each 2D slice, the system identifies the lumen boundary and draws a lumen trace. The lumen area and diameter are determined from this trace.

**Figure 7-4 2D View**

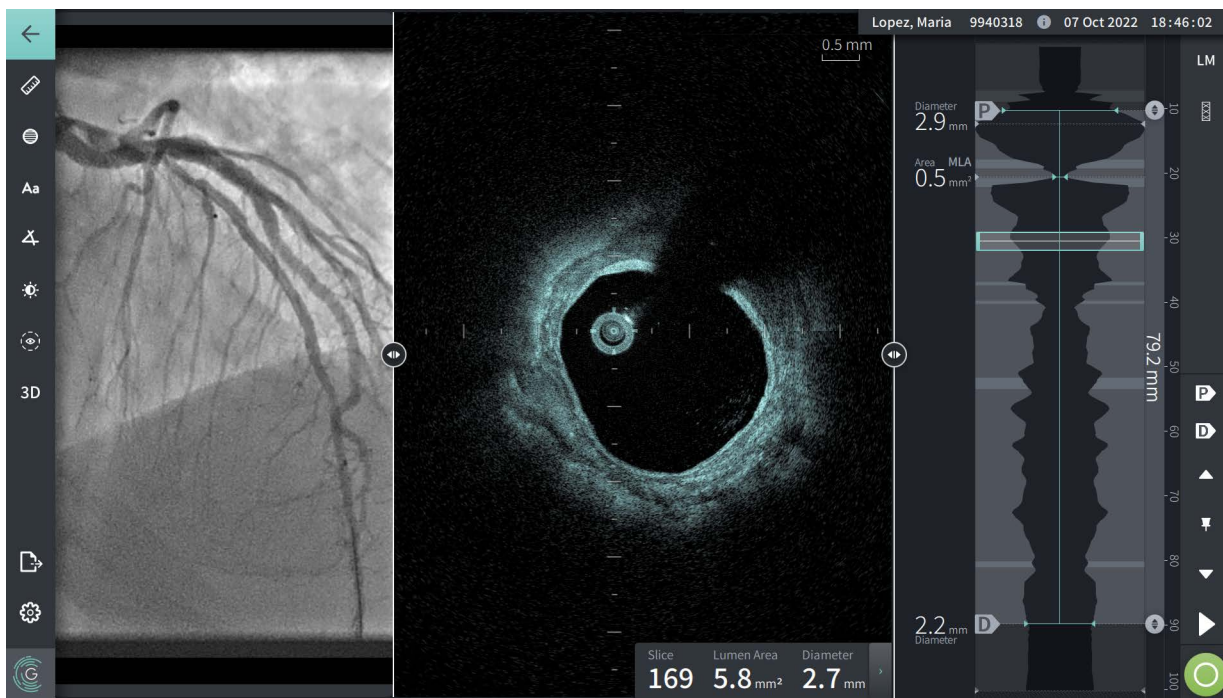

### ➤ To view the lumen trace and edit the points:

---

**Note** — The lumen trace is off (not shown) by default.

---

1. Tap or click on the lumen trace tool (👁️) on the left side of the screen to show the lumen trace control points and to enable editing. You can also tap or click near the lumen boundary on the image to view the lumen trace.
2. To make adjustments, press and hold a move point and then drag the point to the new location as needed. You can eliminate an unwanted point by dragging it to a neighboring point to combine the two points. Add additional points by tapping or clicking the area in which you want to add a point.
3. Tap or click somewhere else on the screen to hide the control points.

## Current Slice Information Panel

After the HF-OCT image is acquired, the software automatically detects the lumen boundary in each cross-sectional slice and displays the area and the diameter for each slice based on the displayed lumen trace, as shown in Figure 7-4 and Figure 7-5.

Based on the lumen trace, the system calculates the area. The diameter is derived from a circle with the same area as the trace.

---

### Notes

- The number of slices may vary slightly for pullbacks that are of the same distance and duration.
  - Image artifacts, such as residual blood from incomplete flushing or sew-up artifact, can affect individual slices of the image. When making a precise measurement, select a slice that is free from artifacts.
- 

Table 7-3 lists and describes the elements in the Current Slice Information Panel.

**Figure 7-5 Current Slice Information Panel**

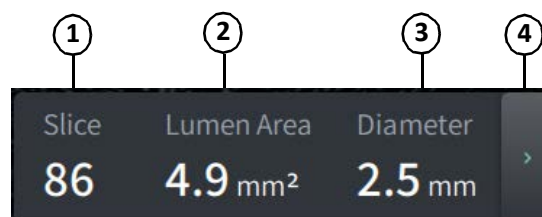

**Table 7-3 Current Slice Information Panel**

Item	Description
1	Current slice
2	Lumen area value
3	Lumen diameter value
4	Control to expand and minimize the Current Slice Information Panel

## Lumen Profile Display

The Lumen Profile display, on the right side of the Image screen, shows the relative area of the vessel lumen along the length of the vessel based on the automatically detected lumen boundary for each 2D view.

The Lumen Profile display is shown with the proximal portion of the vessel at the top and the distal at the bottom of the screen. The guide catheter is automatically detected in the image, and the Lumen Profile is zoomed to show the portion of the pullback in the vessel, outside of the guide catheter.

---

**CAUTION!** Cardiac motion relative to the catheter can cause lengthening and shortening of longitudinal segments of the Lumen Profile and L-Mode, or can create a jagged appearance of the reconstructed image. Do not rely solely on the Lumen Profile or L-Mode for longitudinal measurements.

---

You can perform the following actions on the Lumen Profile display:

- Zoom in on the Lumen Profile by pinching out on the touchscreen or by using Ctrl+scroll wheel on the mouse (press the **Ctrl** key while scrolling the mouse wheel). When you zoom on the Lumen Profile, the most distal portion of the pullback always remains in view and you cannot zoom in past the proximal marker.
- You can adjust the current slice by:
  - Dragging the Current Slice Marker (shown in Figure 7-6 below) to the desired location
  - Touching an area in the Lumen Profile to move directly to that location
  - Scrolling the mouse wheel
- Identify a region or regions of interest within the Lumen Profile by adjusting the Proximal or Distal reference slices. When adjusting the reference slice location, the corresponding 2D view is displayed.
- Designate a slice as proximal or distal by navigating to the desired slice and use the P and D markers in the Reference Markers and Playback Controls Panel accordingly. For details, see “Reference Markers and Playback Controls” on page 7-11.
- Bookmark a slice of interest on the Lumen Profile for reference.
- Use the Stent Expansion feature to automatically detect and display a stent pattern on the Lumen Profile and to display stent expansion. For details, see “Stent Expansion” on page 7-16.

The Lumen Profile display shows the lumen diameter at the Proximal and Distal reference slices and the longitudinal distance between these references. In addition, the system identifies the slice with the smallest lumen area between these two references, labeled as the **MLA** (Minimum Lumen Area) on the Lumen Profile display.

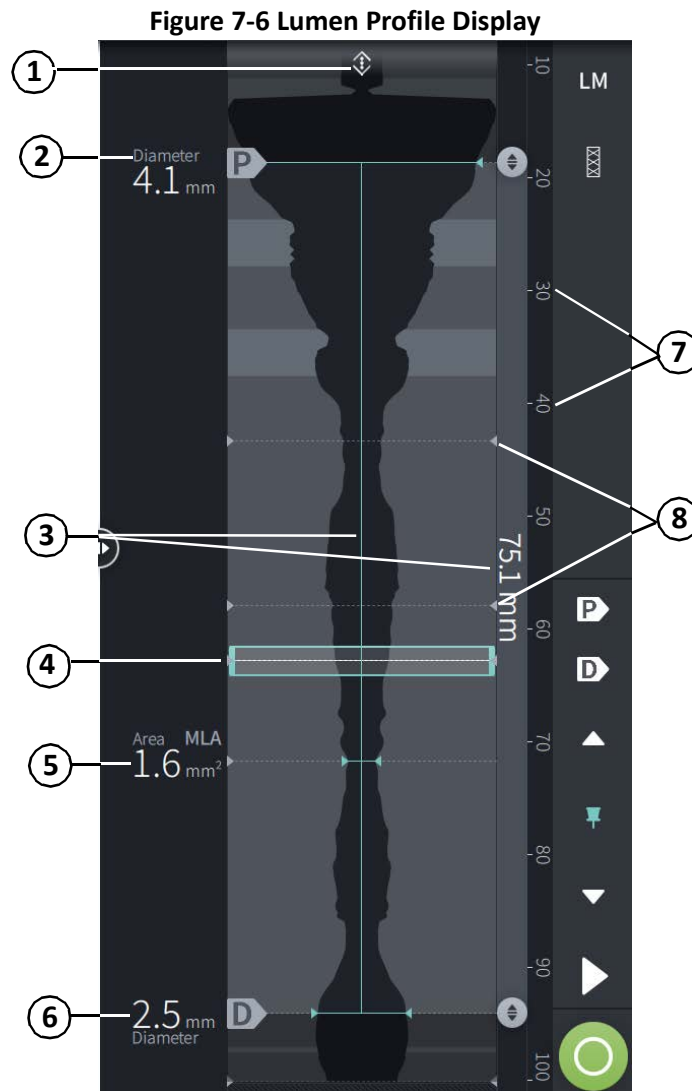

Figure 7-6 shows the elements in Lumen Profile. Table 7-4 lists and describes the elements.



**Table 7-4 Lumen Profile Display**

Item	Name	Description
1	Zoom Indicator	Indicates that the Lumen Profile display has been zoomed and the proximal part of the pullback has been hidden. When the Guide Catheter is detected in the image, the system automatically zooms to exclude it. Selecting this control displays the hidden part of the pullback.
2	Proximal Slice Reference Marker	Defines the proximal end of an area of interest and provides the lumen diameter for that slice. Select the Proximal Slice Reference Marker, or its drag point marker (Ⓢ), and drag it up and down the Lumen Profile Display to adjust proximal slice area of interest. Alternatively, move to a slice in the 2D view and select <b>P</b> to mark that slice as the Proximal Slice Reference.
3	Longitudinal Distance	Indicates the longitudinal distance between the proximal and distal reference slices

**Table 7-4 Lumen Profile Display (Continued)**

Item	Name	Description
4	Current Slice Indicator	<p>The current slice indicator shows the location of the currently displayed 2D image in the pullback. Select anywhere in the Current Slice Indicator to drag it up and down the Lumen Profile Display to navigate to different sections of the pullback, or touch anywhere on the Lumen Profile to jump to that slice.</p> <p>Use the Current Slice Indicator control to navigate to different sections of the pullback. As you drag it, the 2D image updates to match the location and the values in the Current Slice Information Panel are updated to display information about the slice.</p> <p>You can use the mouse scroll wheel to navigate through the slices.</p> <p>You can also use the slice controls to step forward and backward through the annotated slices (including bookmarks): </p>
5	MLA	<p>Indicates the slice with Minimal Lumen Area between the Proximal and Distal Slice Reference Markers and displays the lumen area of that minimum slice. The Minimum indicator is automatically set as the narrowest section of the Lumen Profile Display between the Proximal and Distal Slice Reference Markers and will adjust as needed if you adjust the Proximal and Distal Slice Markers.</p>
6	Distal Slice Reference Marker	<p>Defines the distal end of an area of interest and provides the lumen diameter for that slice. Select the Distal Slice Reference Marker, or its drag point marker () and drag it up and down the Lumen Profile Display to adjust distal slice area of interest. Alternatively, move to a slice and select  to mark that slice as the Distal Slice Reference.</p>
7	Longitudinal distance markers	<p>Markers to show the longitudinal distance from the proximal end of the pullback. If the guide catheter is present, the Lumen Profile is auto-zoomed to crop the guide catheter and the numbers may not start at zero.</p>
8	Measurement/ Annotation/ Bookmark Marker	<p>A small triangle indicates a slice where the user has added a manual measurement, annotation, or has marked the slice with the Bookmark tool to indicate an area of interest. For more information, see “Measurements and Annotations” on page 8-1.</p>



## Reference Markers and Playback Controls

Figure 7-7 shows the Reference Markers and Playback controls that are displayed on the right side of the image screen and Table 7-5 lists and describes each component.

**Figure 7-7 Reference Markers and Playback Controls**

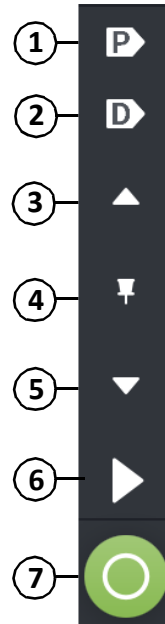

**Table 7-5 Reference Markers and Playback Controls**

Item	Description
1	Control to mark a proximal reference slice on the Lumen Profile.
2	Control to mark a distal reference slice on the Lumen Profile.
3	Control to jump to the next more proximal annotated slice of interest.
4	Control to bookmark a slice of interest. Navigate to a slice of interest and select the bookmark icon to mark that slice. To delete a bookmark, navigate to the bookmarked slice and tap the bookmark icon.
5	Control to jump to the next more distal annotated slice of interest.
6	Play (or Pause). When playing the pullback, tap the Fast Forward control (▶▶) to change the speed of the play. Speeds include regular (no number showing), 2x, 4x, 1/2x, and 3/4x speed.
7	Control to enter the image acquisition workflow to acquire another pullback.

## Navigating the Pullback

There are several ways to navigate in the pullback:

- Scroll the mouse wheel forward or backward over the B-mode or longitudinal views to advance one slice at a time.
- Scroll the mouse wheel forward and backward with the cursor on the angio view to advance approximately one angio frame at a time.
- Touch anywhere in the Lumen Profile to navigate to a specific slice. See Table 7-4 on page 7-9 for more information.
- Drag the Current Slice Indicator to navigate to a different section of the pullback. See “Current Slice Information Panel” on page 7-7 for more information.
- Use the Play and Pause controls as described in “Reference Markers and Playback Controls” on page 7-11.
- Use the Bookmark control to navigate to bookmarked locations as described in Table 7-5 on page 7-11.
- Use the arrow keys on the keyboard to navigate the pullback. The Up and Right arrow keys move proximal in the pullback, and the Down and Left arrows move distal.

## Areas of Uncertainty

When the software detects an unusual lumen shape, such as where a side branch originates or where residual blood obscures the lumen, the slice is identified as *low confidence*.

Figure 7-8 shows an example of an area of uncertainty. In 2D images, the system has several indicators to display low confidence in the automatically detected lumen boundary. Table 7-6 describes the indicators.

You can manually adjust the lumen boundary by touching the boundary and adjusting the control points. When you have adjusted the boundary, it is no longer marked as low confidence.

---

**CAUTION!** Use caution when interpreting the low confidence slices or placing reference markers on a low confidence slice. If measurements are present, you can manually adjust the lumen trace to more accurately identify the lumen boundary.

---

**Figure 7-8 Areas of Uncertainty**

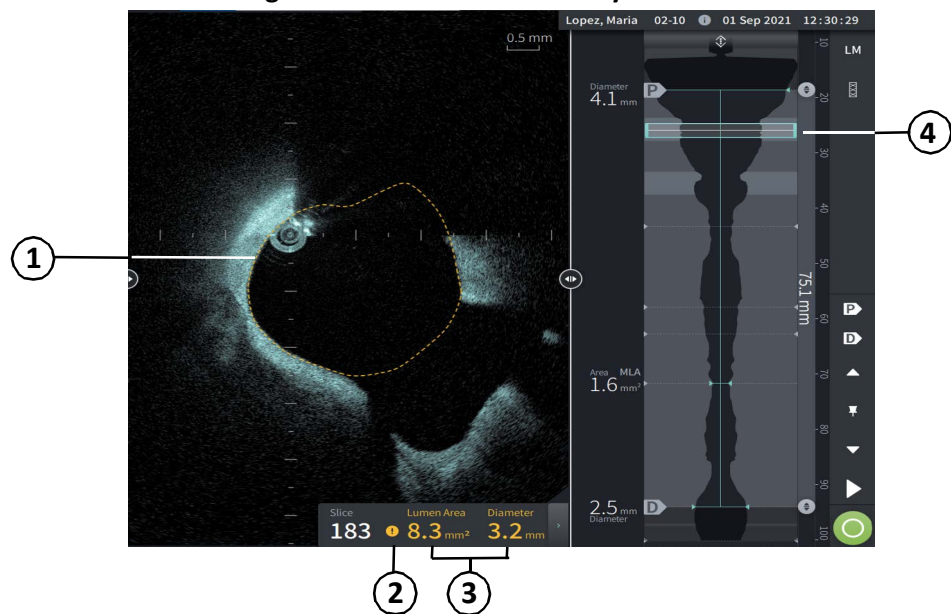
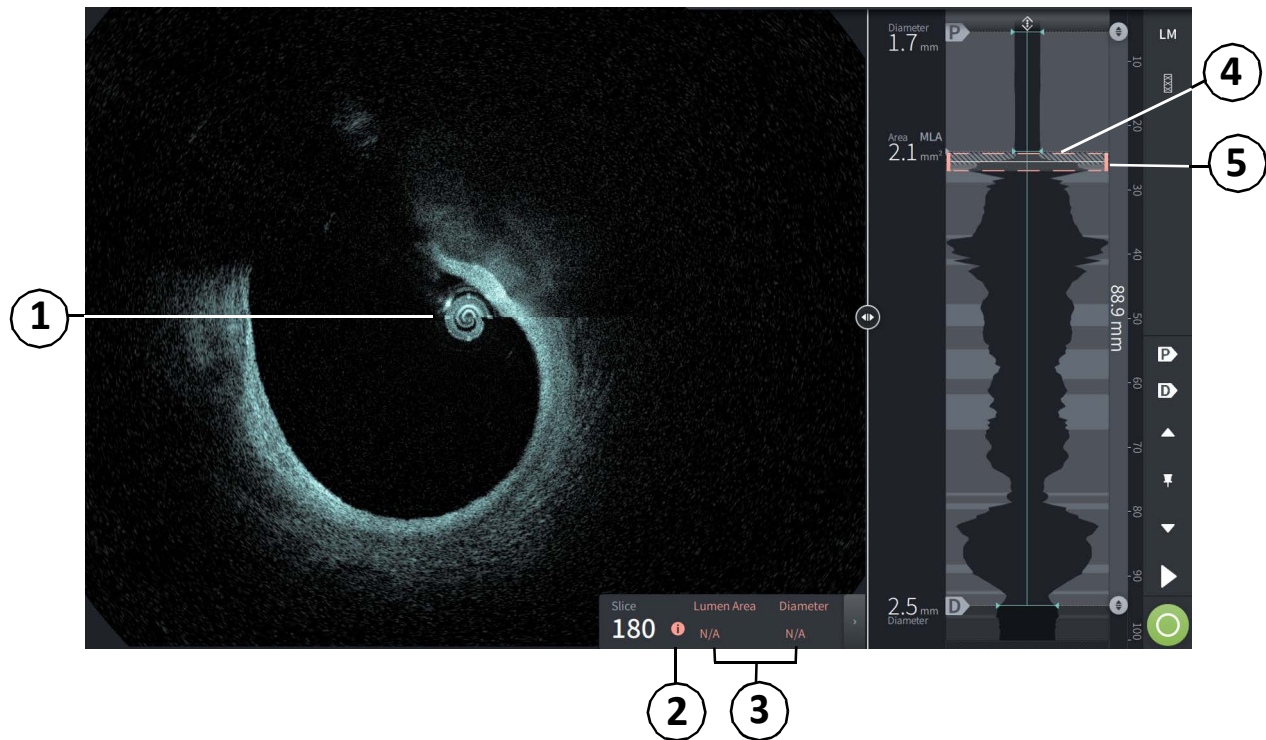

**Table 7-6 Areas of Uncertainty**

Item	Description
1	Lumen Trace is outlined in a dotted yellow line
2	Area of uncertainty  icon is displayed in the panel. When selected, displays the lumen trace with the area of uncertainty. To adjust the area manually, double-click or touch the lumen trace and adjust the points as needed. The area of uncertainty icon no longer appears.
3	Current slice information is displayed in yellow text
4	Lumen Profile shows a lighter shade of gray to indicate a low confidence section

In some rare cases, one or more slices of the pullback may have *very low confidence*. If this occurs, automated and manual measurements are disabled for those individual slices, and those slices cannot be used as the references or identified as the minimum. There are several indicators of a very low confidence slice, as shown in Figure 7-9. Table 7-7 describes the indicators.

**Figure 7-9 Very Low Confidence Slice**



**Table 7-7 Very Low Confidence Slice**

Item	Description
1	No Lumen Trace is displayed.
2	Very low confidence  icon is displayed in the panel. You cannot manually adjust the lumen boundary on a very low confidence slice.
3	Current slice information is marked N/A.
4	Lumen Profile shows a cross-hatch pattern to indicate a very low confidence section.
5	Current slice indicator is outlined in dotted red.

## Additional View Modes

The Genuity High-Frequency OCT Imaging System lets you select from the following additional viewing modes:

- Stent Expansion
- L-Mode
- 3D Mode

### Stent Expansion

Use the Stent Expansion  control to detect and display the stented region on the Lumen Profile, and indicate areas of under-expansion calculated from the Proximal and Distal reference slices, as shown in Figure 7-10. If a stent is not automatically detected, no stent pattern is shown, however you can use the Stent Edit control to indicate a known stent location. Table 7-8 lists and describes the Stent Expansion components.

Figure 7-10 Stent Expansion



#### Notes

- The system only displays a single stented region, which may encompass more than one stent. You can use the Stent Edit control to modify the start and end of the stented region.
- Stent detection is optimized to detect freshly implanted stents, but may also identify an older stent as part of the stented region.

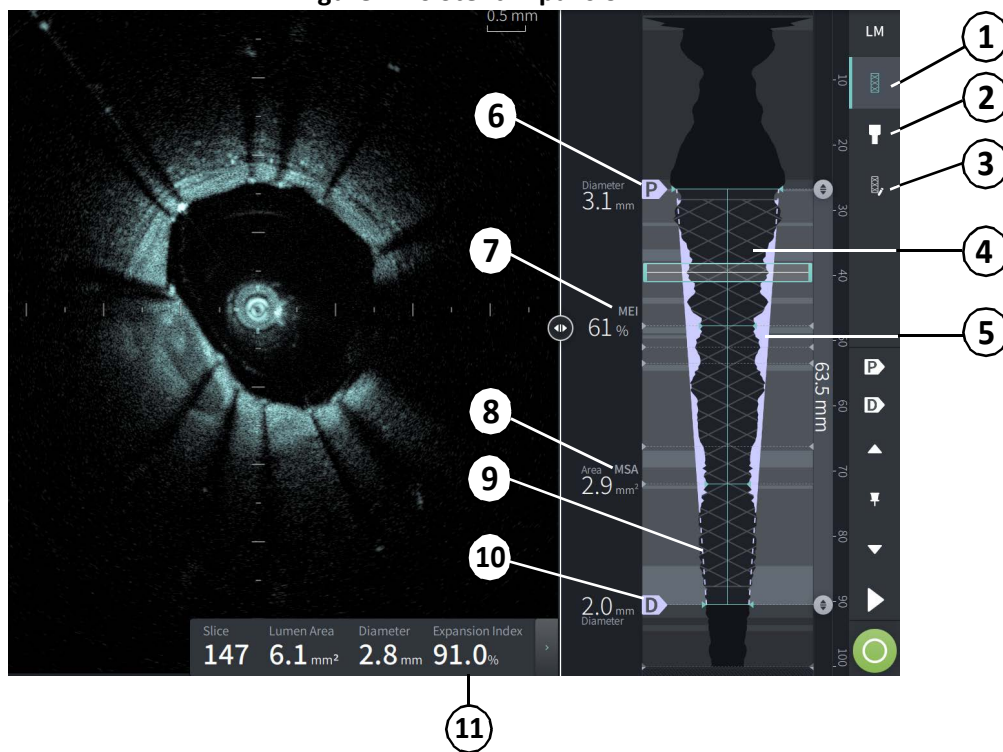
**Table 7-8 Stent Expansion Components**

Item	Description
1	Stent Expansion tool. Use this tool to turn Stent Expansion on and off. When on, the system identifies the stented region of the pullback by displaying the stent pattern on the Lumen Profile. Bifurcation and Stent Edit tools are also displayed. As each Stent Expansion tool is selected, a vertical bar is displayed to the left of the tool to show it is in use.
2	Bifurcation tool. See “Bifurcation Tool” on page 7-18 for more details on this tool.
3	Stent Edit tool. Use this tool to edit the known location of the stent if a known stent is not automatically detected or to modify the detected location. When selected, you can drag the sliders on the Lumen Profile to adjust the stent location.
4	Stent pattern. The stent pattern shows the stented region of the vessel, which may include more than one stent. Use the Stent Edit tool to modify the start and end of the stent.
5	Under-expansion indicator. Colored areas indicate regions where the lumen area is smaller than the reference lumen, as defined by the Proximal and Distal reference slices.
6	Marks the proximal reference slice and its diameter for determining the reference vessel lumen. For more information about the proximal marker, see Table 7-4 on page 7-9.
7	Minimum Expansion Index ( <b>MEI</b> ) on the Lumen Profile indicates the slice with the minimum expansion relative to the reference lumen, and the percent expansion. The MEI is a ratio of the lumen area to the reference lumen area, as determined by the reference slices.
8	Minimum Stent Area ( <b>MSA</b> ) on the Lumen Profile indicates the slice within the stented region with the minimum lumen area and its measurement.
9	Dashed purple lines show the reference vessel lumen based on the proximal and distal reference slices.
10	Marks the distal reference slice and its diameter for determining the reference vessel lumen. For more information about the distal marker, see Table 7-4 on page 7-9.
11	Expansion Index. For each slice within the stented region, the Expansion Index is calculated by taking the lumen area as a percentage of the reference lumen area at that slice, as determined by the reference slices.

For more information on the derivation and use of stent expansion, expansion index and MEI, see the following paper: New Volumetric Analysis Method for Stent Expansion and its Correlation with Final Fractional Flow Reserve and Clinical Outcome: An ILUMIEN I Substudy<sup>1</sup>

<sup>1</sup>. Daisuke Nakamura, William Wijns, Matthew J. Price, Michael R. Jones, Emanuele Barbato, Takashi Akasaka, Stephen W.-L. Lee, Sandeep M. Patel, Setsu Nishino, Wei Wang, Ajay Gopinath, Guilherme F. Attizzani, David Holmes, and Hiram G. Bezerra; J Am Coll Cardiol Intv. 2018 Aug, 11 (15) 1467–1478

## Bifurcation Tool

Use the Bifurcation tool (  ) to indicate a vessel bifurcation within the stented segment. When in bifurcation mode (Figure 7-11), the reference lumen is determined by the proximal reference for the segment proximal to the bifurcation, and by the distal reference for the segment distal to the bifurcation. Slide the control to adjust the location of the bifurcation. To return to the default (tapered) reference lumen, click the bifurcation tool icon.

**Figure 7-11 Bifurcation Tool**

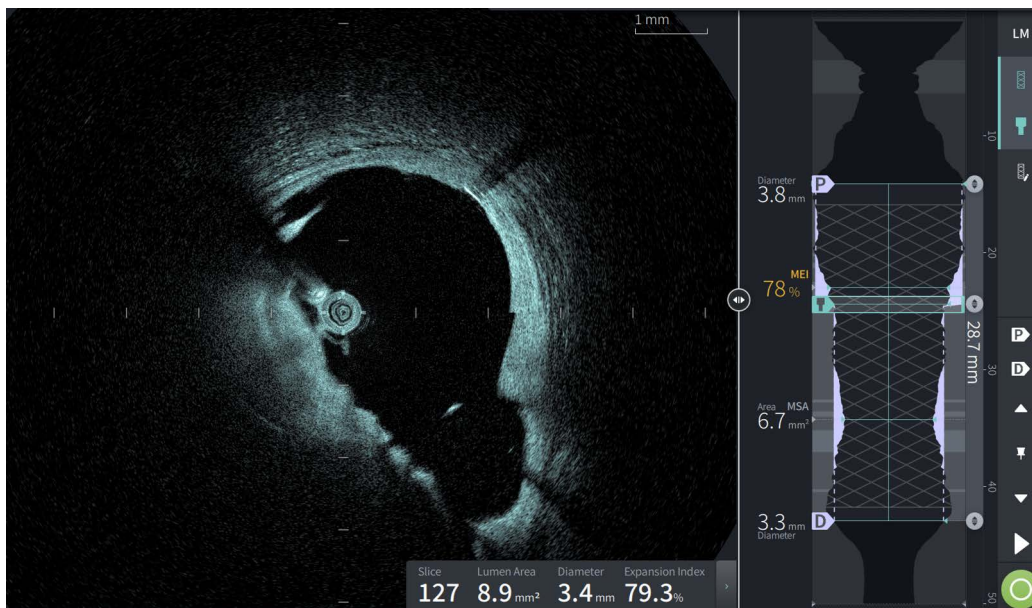



## L-Mode

L-Mode displays a user-selectable, single cut plane image centered on the catheter, made along the length of the pullback and orthogonal to the 2D image. You may change the cut plane by dragging the cut plane indicator on the 2D image.

To show and hide the L-Mode, use the LM control in the upper right section of the screen, as shown.

You can zoom in on the L-Mode and Lumen Profile by using Ctrl+Scroll on the mouse wheel.

Figure 7-12 L-Mode

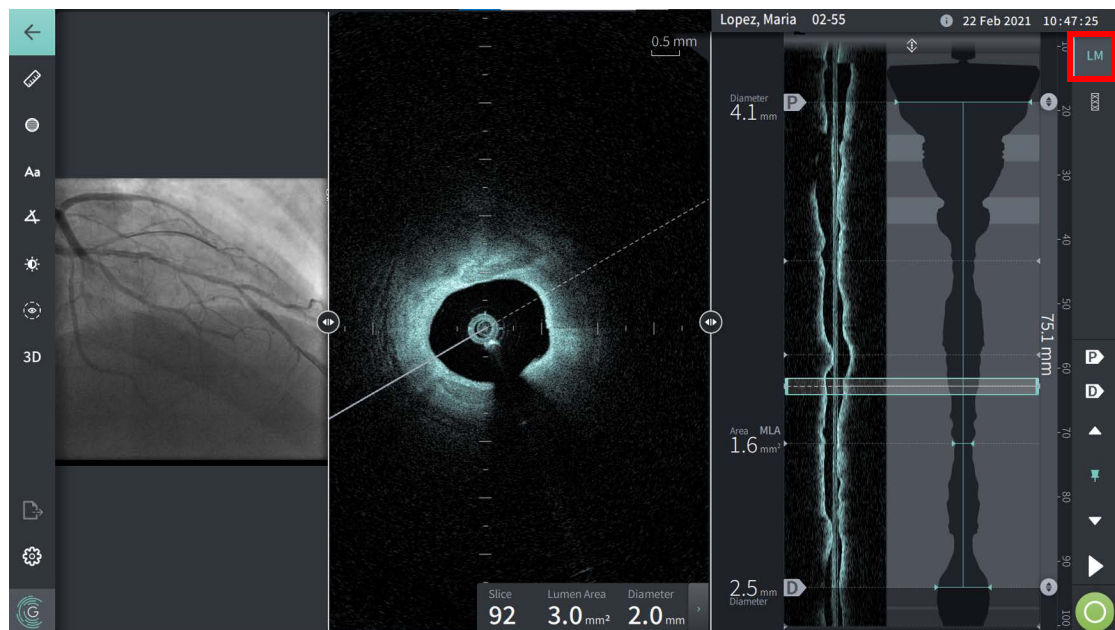

## Limitations

Consider the following limitations when viewing the L-Mode:

- When viewing the pullback, note that the display appears aligned rotationally around the catheter and straight. This is due to the method of image reconstruction.
- Note that the center of the catheter, not the center of the lumen, is the center of the image.

---

**CAUTION!** Because image data is displayed centered around the catheter, off-center catheter locations can make the lumen appear significantly smaller than actual diameter in some L-Mode views. When viewing in L-Mode, rotate the cut-plane to avoid image misinterpretation.

---

### 3D View

The 3D view (Figure 7-13) is based on the longitudinal cut line and gives you a view of the vessel as if it was cut open length-wise.

- Use the 3D control in the Menu Bar on the left side of the screen to switch between 3D view and 2D view.
- Rotate the 3D image by rotating the cut plane line or dragging the 3D image.
- Maximize the zoom setting to display Fly-Through view. For more information, see “Fly-Through View” on page 7-21.

---

**Note** — You can zoom the 3D view as needed.

---

**Figure 7-13 3D View**

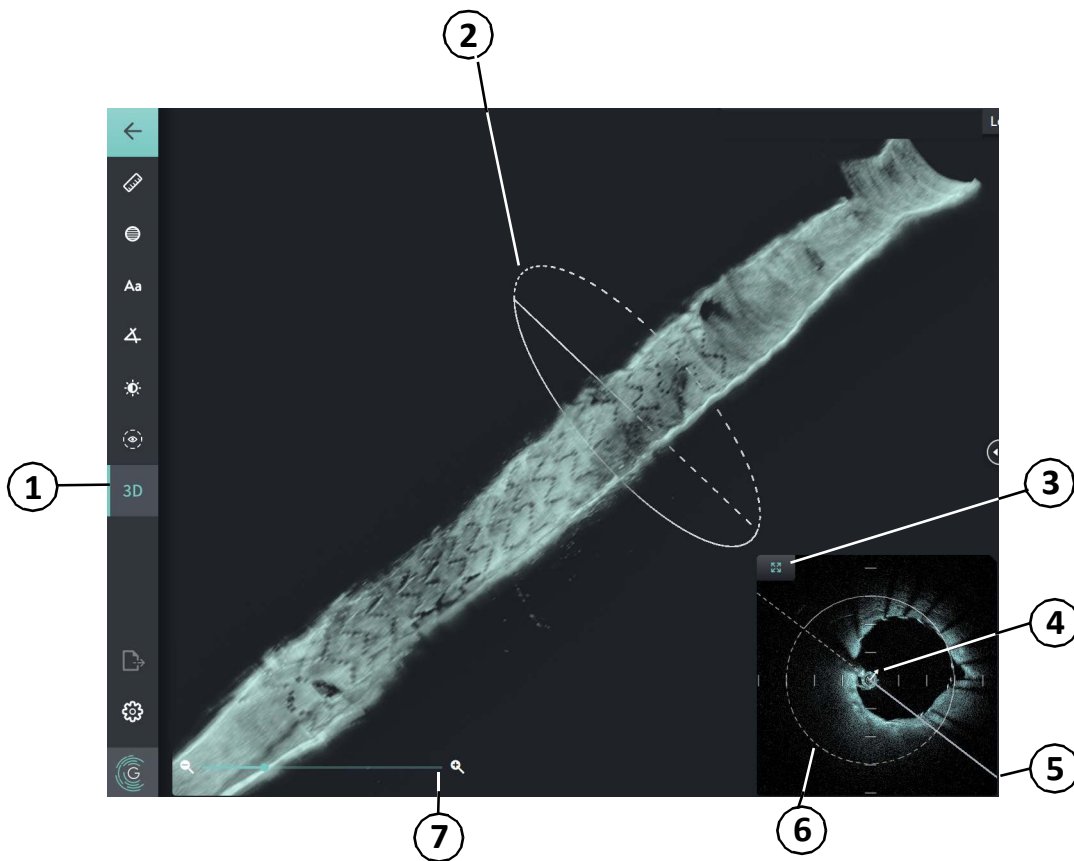

**Table 7-9 3D View Components**

Item	Description
1	3D on/off control to view the image in 3D.
2	Indicates location in vessel and can be rotated to change the 3D view.
3	Icon to close the 3D view and restore the full 2D image.

**Table 7-9 3D View Components (Continued)**

Item	Description
4	Small white arrow indicates direction of view into the 3D vessel.
5	Cut plane; can also be rotated to change the 3D view.
6	Dashed line indicates cutaway; solid line indicates the part of the vessel currently displayed.
7	Control to maximize the zoom to display the fly-through view. You can also maximize the zoom using Ctrl+Scroll on the mouse wheel, or by pinching out on the touchscreen.

## Fly-Through View

The Fly-Through view (Figure 7-14) is displayed when zoom is maximized in 3D view. Fly-Through view enables you to see the inside of the Lumen wall and move through the vessel by adjusting the location on the Lumen Profile display or by scrolling the mouse wheel.

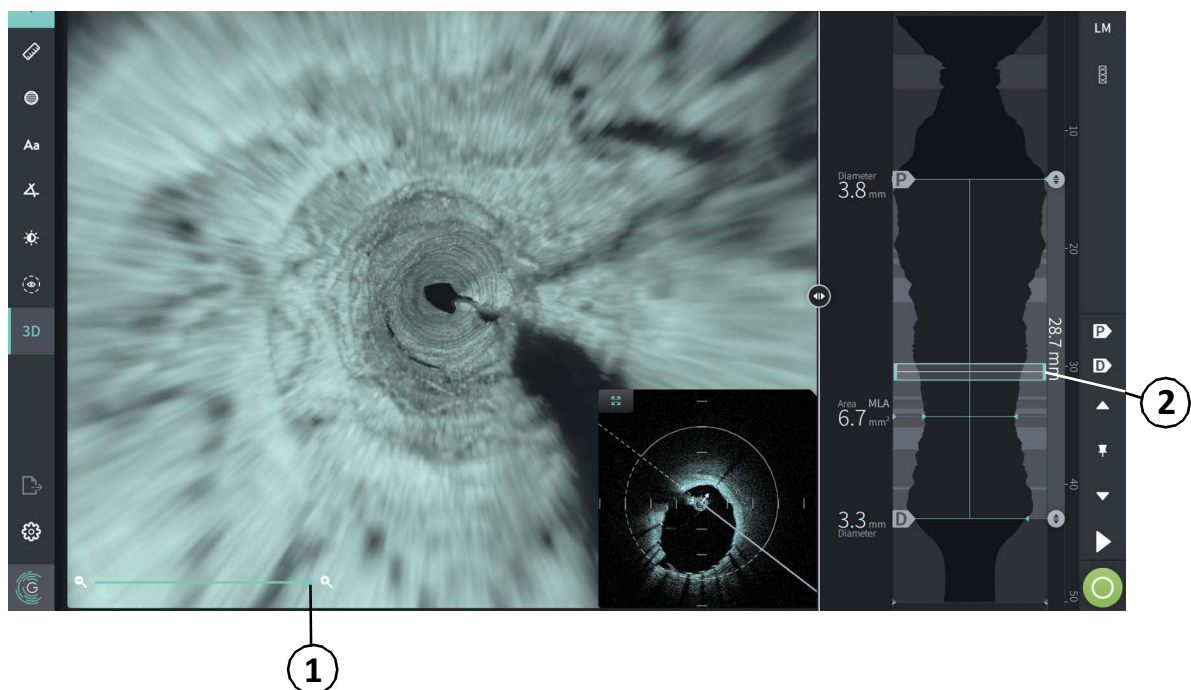
**Figure 7-14 Fly-Through View****Table 7-10 Fly-Through Components**

Item	Description
1	Maximize Zoom to display the Fly-Through view. You can also maximize zoom using Ctrl+Scroll wheel on the mouse or by pinching out on the touchscreen.
2	Use the scroll wheel on the Lumen Profile display to navigate through the vessel.

---

## Viewing Pullback Information

Use the Pullback Information icon (  ) to view the **Pullback Information** window as shown in Figure 7-15. The icon is located in the upper right corner of the Image screen, to the left of the pullback date and time.

The **Pullback Information** window shows detail about the pullback including the date and time it was acquired, the flush medium, pullback setting, slice spacing, trigger method, and the serial number of the acquisition console.

**Figure 7-15 Pullback Information window**

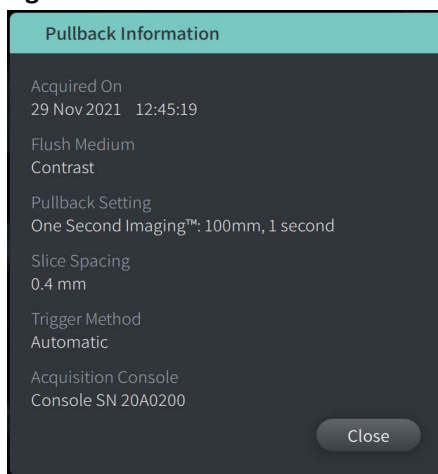

# Chapter 8

## Measurements and Annotations

This chapter provides information and instructions for performing linear, longitudinal, area, and angle measurements and for adding annotations to images in the pullback.

---

### Measurements and Annotations in the Image Files

Measurements and annotations that are added to images do not change the underlying image data. The unannotated image is always preserved and can be reviewed without the measurements and annotations. Measurements and annotations added during the procedure are preserved in the file.

---

#### CAUTIONS!

- If you want to make measurements on files which will be exported in standard formats (such as MP4, JPEG, and PDF), you must make the measurements BEFORE exporting the images.
- Using non-OCT software to measure standard format images will not produce accurate measurements.
- Do not use images that have been exported in standard formats (such as MP4, JPEG, and PDF) for clinical decision making. This format uses compression methods that may degrade the image quality.

---







#### Notes

- All measurements and annotations can be made in the 2D view of the HF-OCT image, but only longitudinal measurements can be made in the Lumen Profile and the L-Mode views. No measurements are allowed in the 3D view.
  - Measurements are not allowed in slices with very low confidence (see “Areas of Uncertainty” on page 7-11). Move to an adjacent slice to make measurements.
-

## Measurement and Annotation Tools

As measurements and annotations are added to the image, they are labeled with successive control letters (A, B, C, and so on). Table 8-1 lists and describes the measurement and annotation tools.

**Table 8-1 Measurement and Annotation Tools**

Tool Icon	Name	Description
	Linear/longitudinal measurement	Perform a linear measurement by placing two calipers on the 2D image. Perform a longitudinal measurement by placing two calipers on the Lumen Profile or on the L-Mode view.
	Area measurement	Perform an area measurement by tracing the outline of an area. The system calculates the area within the user-defined trace.
	Annotations	Add annotations/notes/comments to image. <b>CAUTION:</b> Do not use personally identifiable information in annotations. Annotations do NOT get anonymized.
	Angle measurement	Perform an angle measurement by placing a right angle on the image and then adjusting the angle.
	Image Adjustment	Adjust the image's contrast and brightness.
	Lumen Trace Boundary	Show and hide the Lumen Trace Boundary on the 2D view
	3D view	Show and hide the 3D view of the current image. For more information on 3D view, see "3D View" on page 7-20.

**Note** — Measurements are indicated with a small marker in the Lumen Profile display on the right side of the screen.

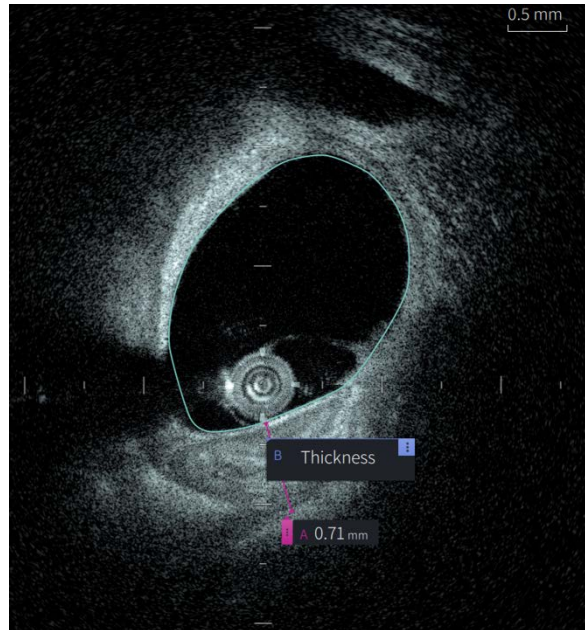
**Figure 8-1 Measurements and Annotations**

---

## Techniques to Improve Measurement Accuracy

Follow these guidelines to improve measurement accuracy:

- Before making measurements, use the zoom function to zoom into the region of interest until you can clearly see borders and other features you want to measure.
- Place the measurement cursor on the image, using the same measurement technique each time you perform the same type of measurement.
- Use the mouse to make fine adjustments when placing endpoints.

---

## Measurements and Annotations in L-Mode View

All annotations and measurements can be made in the 2D area of the image window. Only longitudinal measurements, useful for determining vessel segment length, are permitted in the L-Mode view and Lumen Profile view.

## Linear and Longitudinal Measurements

The system calculates and displays length as the distance in millimeters (mm) between two points placed on an image in the 2D, Lumen Profile, or L-Mode views.

As you perform each linear or longitudinal measurement, the results are labeled alphabetically and shown in a Measurement Result Tag associated with that measurement, as shown in Figure 8-2 and Figure 8-3.

For more information, see “Measurement Results Tag” on page 8-11.

**Figure 8-2 Linear Measurement on Image**

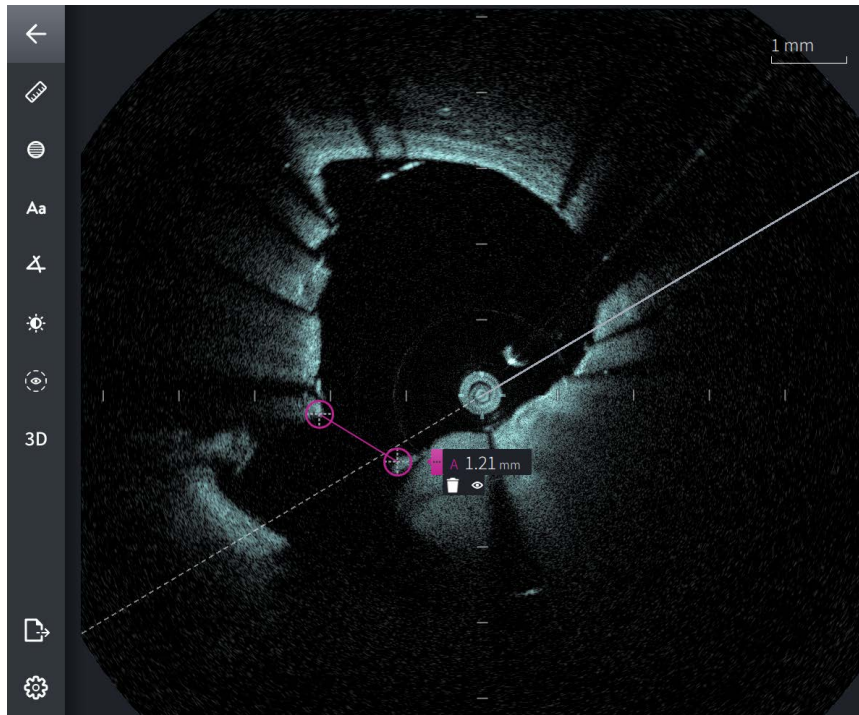

**Figure 8-3 Linear Measurement on Lumen Profile**

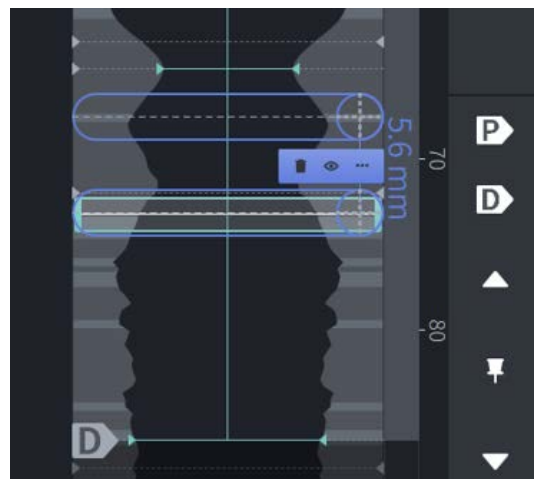



## Performing a Linear or Longitudinal Measurement

Measurement markers are displayed on the Lumen Profile Display, as shown in Figure 7-6 on page 7-8.

You can perform a linear measurement on the 2D image, or longitudinal measurements on the Lumen Profile or L-Mode views.





---

**Tip** — Zoom the image in the area of interest before making any measurements.

---

### ➤ To perform a linear or longitudinal measurement:

1. With the slice displayed in image review, select the linear/longitudinal measurement icon: 
2. Do either of the following:
  - To start a linear measurement, touch or click the start of the linear measurement on the 2D image.
  - To start a longitudinal measurement, touch or click the start of the longitudinal measurement on the Lumen Profile or on the L-Mode.

A caliper is displayed on the image.
3. Touch or click the end of the linear or longitudinal measurement. A second caliper is displayed, connecting the line. The measurement tag is displayed with the value, as shown in Figure 8-2 and Figure 8-3.
4. Do any of the following:
  - To make adjustments to either end point, touch and hold to display the caliper and then drag the point to the new location.
  - To delete the measurement, touch or click the measurement's delete  icon.
  - To show or hide the measurement tag tools, touch or click the  icon.
  - To show or hide only the measurement tag (for example, F 3.56 mm) touch or click the show  icon or hide  icon.
  - To complete the measurement, touch or click in another area of the image or Lumen Profile.
5. To perform another linear or longitudinal measurement, repeat the steps above.

---

## Area Measurements

You can manually create a closed area trace of a feature in 2D view. The area is calculated using Green's Theorem, and is displayed in the slice in  $\text{mm}^2$ .

As you perform each area measurement, the results are shown in the Measurements Results Tag, as shown in Figure 8-4.

For more information, see "Measurement Results Tag" on page 8-11.

**Figure 8-4 Area Measurements**

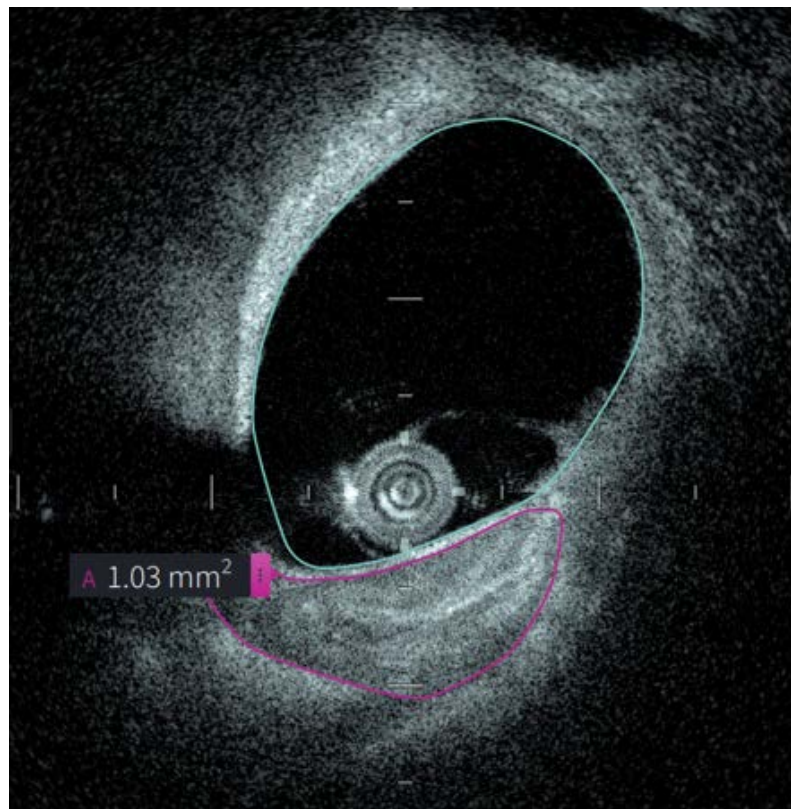

## Performing an Area Measurement







Measurement markers are displayed on the Lumen Profile Display, as shown in Figure 7-6 on page 7-8.

---

**Tip** — Zoom the image in the area of interest before making any measurements.

---

### ➤ To perform an area measurement:

1. With the slice displayed in image review, select the area measurement icon: 
2. Drag your finger around the area to be defined or click and drag the mouse.
3. To make adjustments, press and hold a caliper point  and then drag the point to the new location as needed. You can eliminate an unwanted point by dragging it to a neighboring point to combine the two points. Add additional points by tapping or clicking the area in which you want to add a point.
4. Do any of the following:
  - To delete the area measurement, touch or click the measurement's delete  icon.
  - To show or hide the measurement tag tools, touch or click the  icon.
  - To show or hide only the measurement tag (for example, F 3.56 mm) touch or click the show  icon or hide  icon.
  - To complete the measurement, touch or click in another area of the image.
5. To perform another area measurement, repeat the steps above.

---

## Annotations

Use the annotation tool  and system keyboard to add notes to the image.

As you enter each annotation, the annotations are labeled alphabetically in the Measurements Results Tag, starting with the next available letter, as shown in Figure 8-5.

For more information, see “Measurement Results Tag” on page 8-11.

---

**CAUTION!** Do not use personally identifiable information in annotations. Annotations do NOT get anonymized.

---

**Figure 8-5 Annotations**

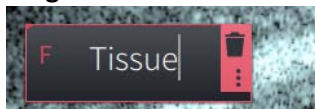



## Adding Annotations

Annotations and measurement markers are displayed on the Lumen Profile Display, as shown in Figure 7-6 on page 7-8.

If necessary, zoom the image in the area of interest before adding any annotations.

### ➤ To add an annotation:

1. With the slice displayed in image review, select the annotation tool icon: .
2. Touch or click the area where you want to add the annotation. The annotation tag is displayed on the image.
3. Enter the annotation text in the note field. To add a line break, press the **Shift + Enter** keys.
4. Do any of the following:
  - To edit the text, touch or click the text area and re-enter the text.
  - To delete the annotation, select the annotation and touch or click the delete  icon.
  - To complete the annotation, touch or click in another area of the image.
  - To move the annotation, drag it to the new location.
5. To add another annotation, repeat the steps above.

---

## Angle Measurements

You can create an angle measurement on the image and adjust the center vertex and angle degrees as needed.

As you perform each angle measurement, the results are shown in the Measurement Results Tag, as shown in Figure 8-6.

For more information, see “Measurement Results Tag” on page 8-11.

**Figure 8-6 Angle Measurements**

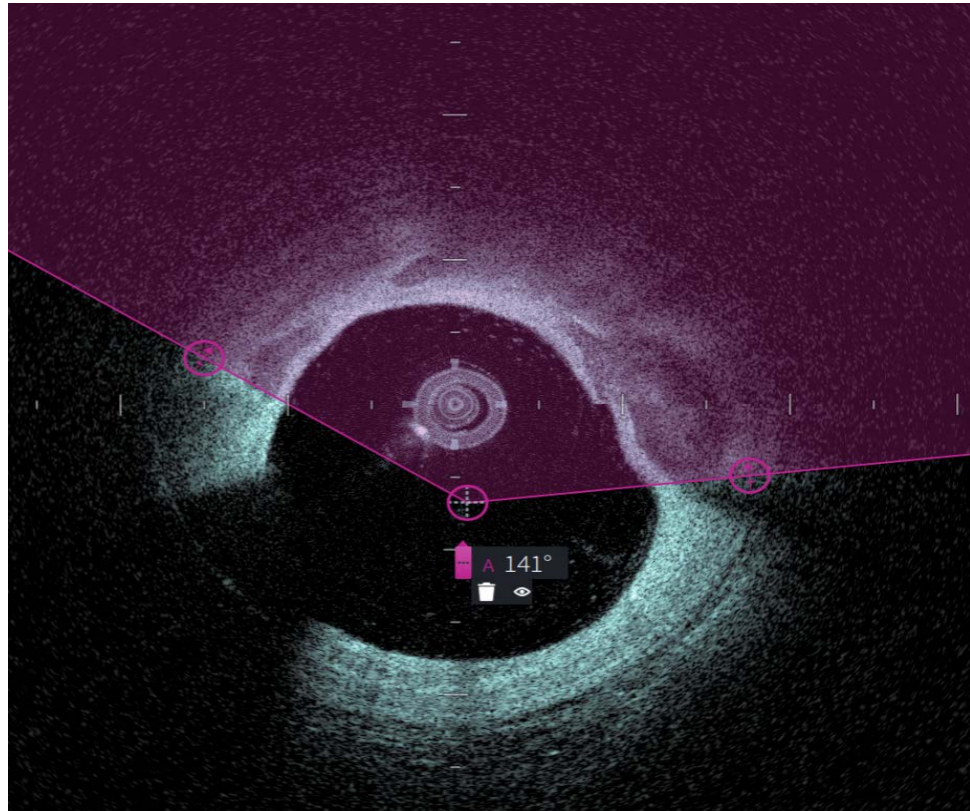

## Performing an Angle Measurement







Measurement markers are displayed on the Lumen Profile Display, as shown in Figure 7-6 on page 7-8.

---

**Tip** — Zoom the image in the area of interest before making any measurements.

---

### ➤ To perform an angle measurement:

1. With the slice displayed in image review, select the angle measurement icon: 
2. A 90-degree angle is displayed on the screen with the vertex at the center of the lumen. You can adjust the vertex location by moving the center control point.
3. Drag the caliper points  to adjust the angle width. The shaded area indicates the angle being measured.
4. Do any of the following:
  - To delete the angle measurement, touch or click the measurement's delete  icon.
  - To show or hide the measurement tag tools, touch or click the  icon.
  - To show or hide only the measurement tag (for example, A 18°) touch or click the show  icon or hide  icon.
  - To complete the measurement, touch or click in another area of the image.
5. To perform another angle measurement, repeat the steps above.



## Measurement Results Tag

As you perform each measurement or add an annotation, the Measurement Results Tag is displayed, as shown in Figure 8-7. Table 8-2 lists and describes the tag.

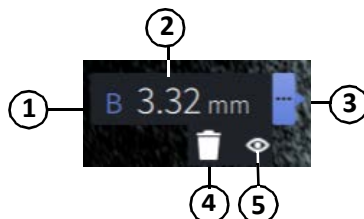
**Figure 8-7 Measurement Results Tag**



**Table 8-2 Measurement Results Tag**

Item	Description
1	Measurement or annotation label.
2	Measurement value or text entry for annotations.
3	Click this icon to access additional tag tools (callouts 4 and 5) and to edit the measurement or annotation.
4	Deletes the measurement or annotation.
5	Shows and hides the tag for the user-generated measurement. The line or area remains visible, but the tag is hidden. When you click the user-generated line or area, the tag reappears, along with the  and  icons. This icon is only visible for user-generated measurements. It does not appear for annotations.





# Chapter 9

## Exporting Patient Records and Pullbacks

This chapter provides information and instructions for exporting patient records, exporting pullbacks and image files, and configuring the Genuity High-Frequency OCT Imaging System to allow export via USB and network transfer.

---

### Overview

The system allows export of full patient records, selected pullbacks, or selected images from pullbacks.

There are two methods for exporting data: to USB connected media or via network transfer to a configured network server.

---

**CAUTION!** Genuity makes no representation or warranty that use of the Genuity High-Frequency OCT Imaging System complies with applicable privacy, security and confidentiality laws, but encourages you to assess your own risk as you use, disclose, control, process or transfer patient health information with the Genuity High-Frequency OCT Imaging System.

---

### Exporting Via USB Connected Media

You can export individual and multiple patient records, and image files (pullbacks) via USB connected media in a range of file formats. For details on exporting patient records via USB, see page 9-7. For details on exporting pullbacks and image files, see page 9-12.

---

### Notes

- To improve export speed of the large Genuity image files, Genuity recommends using a USB drive that meets the USB 3.0 or newer specification.
  - Exporting patient records requires that a USB drive be inserted into the USB port on the Genuity High-Frequency OCT Imaging System. If the USB drive is not detected, the **Export** icon  is visible but dimmed and not available until a USB drive is detected.
  - Do not remove the USB drive during the export function. Verify that the data transfer is complete before removing media.
- 

## Exporting Via Connected DICOM PACS Server

You can export individual and multiple patient records in DICOM format to a connected DICOM PACS server. For details on adding, configuring, testing, and editing DICOM PACS servers, see “Configuring Network Server Settings for Export” on page 9-3. For details on exporting patient records to a network server, see page 9-7.

---

## Restricting Access to USB Drive

Access to the USB drive can be restricted such that patient data export, log export, and hospital logo upload require the Administrator password.

When **USB Drive Access** is configured to require a password, the Export icon () in the left side panel is dimmed but accessible, and the user is notified that a password is required when USB is selected as the export media type. For details on configuring the Administrator password, see “About the Administrator Password” on page 4-9.

---

## Configuring Network Server Settings for Export

This section provides information and instructions for viewing **Network Adapter Information** and configuring the Genuity High-Frequency OCT Imaging System to allow export of patient records to the hospital's DICOM PACS server.

When you export patient records to the hospital's network server, the data is exported in DICOM SC format. You can configure network exports to use TLS encryption. For details, see "Configuring Network Export Server(s)" on page 9-4.

### Viewing Network Adapter Information

The **Network Adapter Information** shows the interface name, MAC address, and IP address, as shown in Figure 9-1. Provide this information to your hospital IT department when configuring network settings.

Figure 9-1 Network Adapter Information

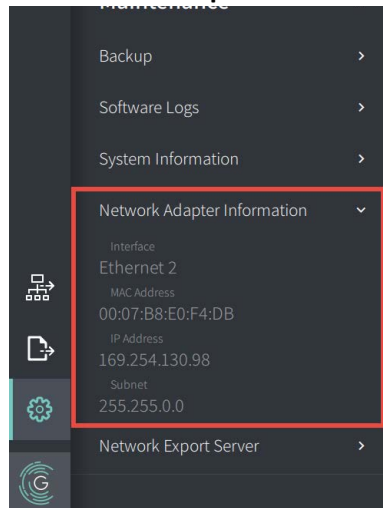

To view **Network Adapter Information**:

1. Select **Settings** and then **Maintenance**.
2. Select **Network Adapter Information**.

## Configuring Network Export Server(s)

Use the **Network Export Server** settings to add a new server, edit existing server information, and test a server's connection. You can configure multiple servers. When only one server is configured, it is automatically labeled as the default server. When multiple network servers are configured, you must specify which server is the default.

For added security, you can configure an Administrator password to prevent unauthorized server configuration changes. For details on configuring the Administrator password, see "About the Administrator Password" on page 4-9.

---

**Note** — An Ethernet cable connection is required to export patient data to a network. For details, see "Input/Output Connections" on page 3-4.

---

### Adding a Network Server

To add a new network server:

1. Select **Settings** and then **Maintenance**.
2. Select **Network Export Server** (Figure 9-2).

**Figure 9-2 Network Export Server Settings**

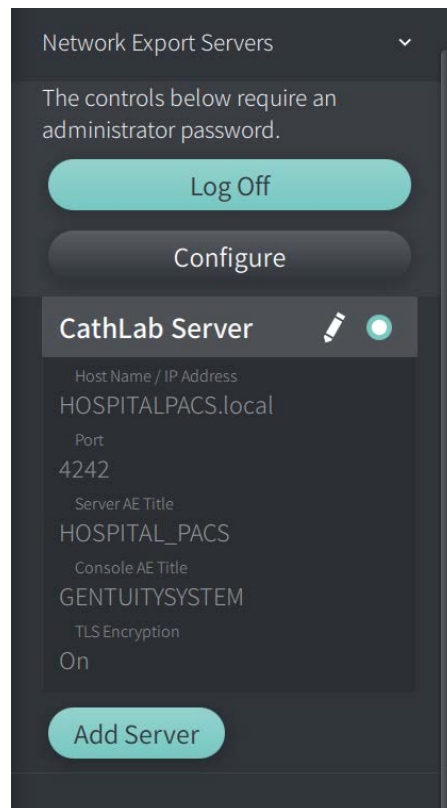

3. To prevent unauthorized configuration changes to the network server, tap **Configure** to configure an Administrator password. Follow the on-screen prompts and then click **Save**.

4. Select **Add Server**. The **Add Network Export Server** window is displayed (Figure 9-3).

**Figure 9-3 Add Network Export Server**

5. Enter the following server information. Consult your hospital IT department for more information.
  - **Displayed Server Name:** Name as displayed to users
  - **Host Name/IP Address:** Host name or IP Address
  - **Port:** Port number
  - **Server AE Title:** Application Entity (AE) Title for destination server
  - **Console AE Title:** Application Entity (AE) Title for the HF-OCT console
  - **Use TLS Encryption (On or Off):** To enable Transport Layer Security (TLS) Encryption, your hospital server must be configured to use this extended encryption of network data transfers. Consult with your hospital IT department for details.
  - **Make Default:** If more than one server is configured, you must specify which is the default server. If only one server is configured, it is automatically the default.
6. Select **Test Connection** to test the settings.
7. Select **Save** to save the server settings.

### Editing and Testing a Network Export Server

To edit a network server and test its connection:

1. Select **Settings** and then **Maintenance**.
2. Select **Network Export Server**.
3. Select the server to edit and tap the pencil icon (  ) associated with the server (Figure 9-4).

---

**Note** — The green and white circle icon (  ) in Figure 9-4 indicates this server is the default network server.

---

**Figure 9-4 Edit Network Export Server**

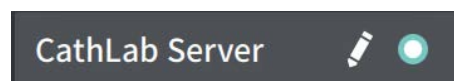

4. To test the network connection, tap **Test Connection**.
5. Edit the server information as needed and then tap **Save**.

## Exporting Patient Records from the Patient List

The system allows export of full patient records, selected pullbacks, or selected images from pullbacks.

Each patient record contains all pullbacks and image files obtained by the Genuity High-Frequency OCT Imaging System.

There are two methods for exporting data: to USB connected media or via network transfer to a configured network server. Only full patient records in DICOM format can be exported via network transfer.

### Notes

- Use the Export icon (📁➔) to export to a USB drive. If the icon is visible but dimmed, it indicates that the Administrator password is required to access the USB drive, or that a USB drive is not inserted.
- Use the Network icon (🌐) to export to a network export server. If the icon is visible but dimmed, it indicates that a network server has not been added and configured for your system, or the Ethernet cable is not connected to the console. Contact your hospital IT department for more information.

When exporting patient records, the system prompts you to select options.



Figure 9-5 shows the **Database Export** screen where you select whether to export patient records by patient or by date of acquisition.

Figure 9-5 Database Export

The screenshot shows the 'Database Export' interface. On the left, there are options for 'Export Method' (Patient or Date), 'Select Archive Option' (Leave as is or Delete from system), and 'Export File Type' (Genuity Format or DICOM SC). The main area displays a table titled 'Select Patient Files to Export' with columns for Patient ID Number, Last Name, First Name, Date of Birth, Images, Last Acquired, and Physician. The table contains 18 rows of patient data.

Patient ID Number	Last Name	First Name	Date of Birth	Images	Last Acquired	Physician
002819998	DelMonico	Elizabeth	11 Aug 1942	1	02 Apr 2019	Michaels
0133335	Price	Roger	16 Mar 1959	2	28 Mar 2019	James
013354	Galvano	Anthony	04 Mar 1959	2	22 Mar 2019	Michaels, Ro...
01347918234...	Aleksandrovich Ra...	Marko	25 Aug 1930	3	29 Mar 2019	
01848373	Chen	Barbara	05 May 1955	2	28 Mar 2019	
019387	Chaves	Rodney	12 Dec 1972	2	26 Mar 2019	Carter
0193887	Dawson	Kristina	10 Oct 1970	2	26 Mar 2019	
02149713829...	Howlett	James	12 Oct 1968	2	18 Dec 2018	
02345	Vella	David	08 Jan 1965	2	27 Mar 2019	Michaels
0289903716	Ortiz	Jaime	05 Apr 1948	7	16 Apr 2019	Michaels, Ro...
0391619123	Ripley	Ellen	08 Oct 1949	2	18 Dec 2018	James
0398745	Mason	Mary	09 Mar 1969	2	28 Mar 2019	James
04164336788	Fortition	Aaron	11 May 1955	2	28 Mar 2019	Carter
0429778470	Traithorn	Christopher	12 Jul 1972	2	28 Mar 2019	Michaels
0463889201	Burns	Phillip	16 Sep 1976	2	25 Apr 2019	James
04701938401	Malcolm	Ian	22 Oct 1952	2	18 Dec 2018	
0477494893	Deaton	Nikolai	26 Jan 1978	2	28 Mar 2019	

➤ **To export patient records from the Patient List:**

1. Do either of the following:
  - If exporting to a USB drive, make sure the USB drive is inserted into the USB port on the system.
  - If exporting to a network server, make sure the Ethernet cable is connected to the Genuity High-Frequency OCT Imaging System and to the network server.
2. With the **Patient List** displayed, select  or  to display the **Database Export** menu, as shown in Figure 9-5. If configured, a message may be displayed that the Administrator password is required to export.
3. Do either of the following:
  - To export specific patient records, select the **Patient** button and then select each patient record to include in the export. A check box is displayed in the **Patient List** for each patient record that you select. You can also select the **ALL** button (located at the top of the first column) to select all patient records:



- To export patient records by the date of their last acquisition, select the **Date** button and select the date range. A calendar is displayed where you can select the < and > icons to view other months. Select the first date and then select the second date to specify the range. The date range is displayed on the calendar.

**Figure 9-6 Export by Date**

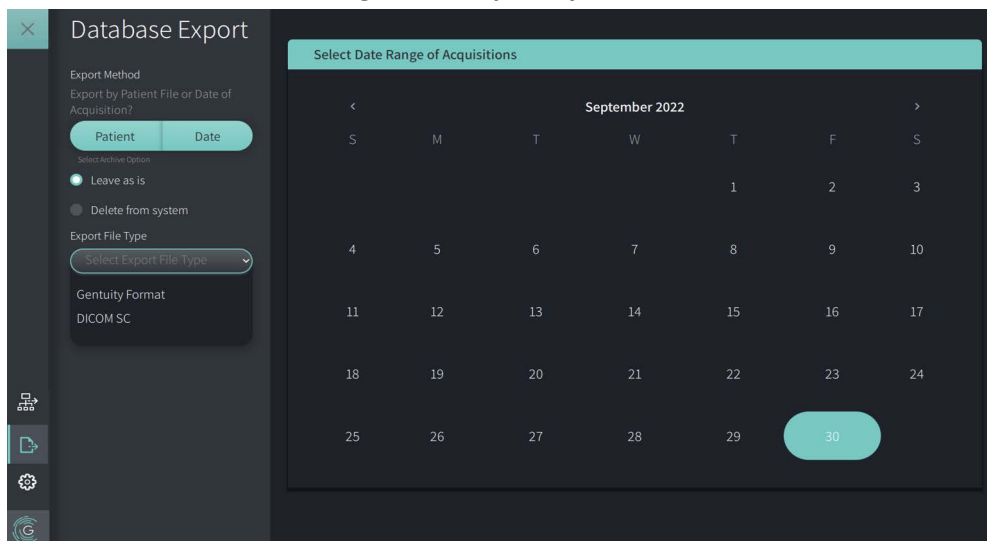



4. Choose one of the following **Archive Options**:
  - To export the patient records without making any changes to the record, select **Leave as is**.
  - To export the patient records and delete the records from the system, select **Delete from system**.

---

**CAUTION!** Deleting files from the system frees up storage space on the system but the deleted files cannot be imported back into the system.

---

5. Do either of the following:
  - If exporting to a USB drive, select the **Export File Type** drop-down and then select the file format and the export options. For details on each, see “Export File Formats” on page 9-17 and “Export Settings” on page 9-19.

Proceed to Step 1 in “Exporting to a USB Drive” on page 9-10 to continue.

- If exporting to a network server, select the network server from the **Network Server** drop-down and specify the **Export Settings** (Figure 9-7). When exporting to a network server, files are only exported as the DICOM SC file type.

Proceed to Step 1 in “Exporting to a Network Server” on page 9-11 to continue.

**Figure 9-7 Select a Network Server**

The screenshot shows a dark-themed dialog box titled "Network Export". At the top left is a close button (X). The dialog is organized into sections:

- Export Method:** "Export by Patient File or Date of Acquisition?" with two buttons: "Patient" and "Date".
- Select Archive Option:** Two radio buttons: "Leave as is" (which is selected) and "Delete from system".
- Network Server:** A dropdown menu currently displaying "CathLab Server".
- Export File Type:** A dropdown menu displaying "DICOM SC".
- Export Settings:** A dropdown menu for "Select File Size / Quality" displaying "Large / High".

An "Export" button is located at the bottom right of the dialog. In the bottom left corner, there is a small icon representing a network or server connection.

## Exporting to a USB Drive

1. Select **Export**. If configured, you may be prompted to enter the Administrator password to continue.

The **Select a Directory** window is displayed (Figure 9-8), prompting you to select a directory or to create a new folder for the archive.

**Figure 9-8 Select a Directory**

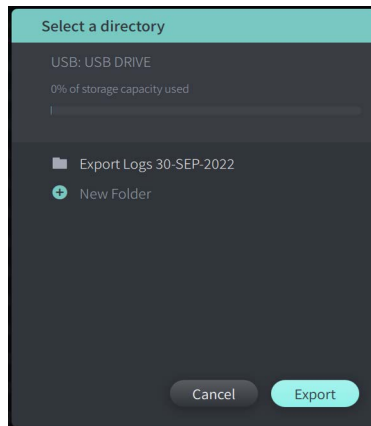

2. Select an existing directory on the USB drive, or select **New Folder** and enter the name of the new folder.
3. Select **Export**. The **Progress** screen is displayed as the records are exported from the system to the USB drive (Figure 9-9).

**Figure 9-9 Export Progress (USB Drive)**

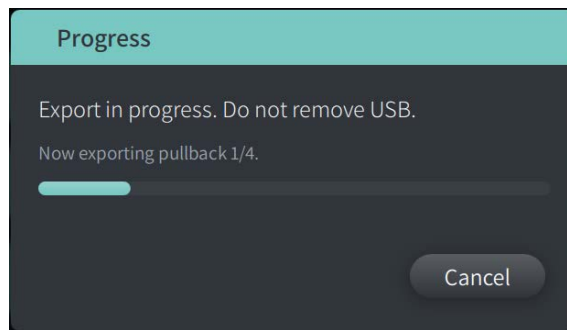

4. Allow the export to continue or select **Cancel** to cancel the export.
5. When the export is complete, the **Export Complete** screen is displayed, as shown in Figure 9-10. You may remove the USB drive and then click **OK**.

**Figure 9-10 Export Complete (USB Drive)**

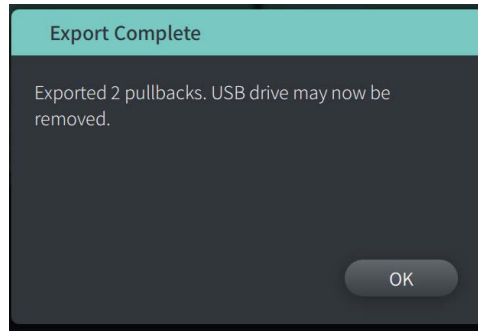

### Exporting to a Network Server

1. Select **Export**. The **Progress** screen is displayed as the selected records are exported from the system to the network server (Figure 9-11).

**Figure 9-11 Export Progress (Network Server)**

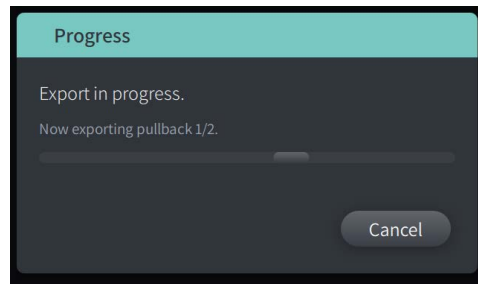

2. Allow the export to continue or select **Cancel** to cancel the export.
3. When the export is complete, the **Export Complete** screen is displayed, as shown in Figure 9-12. Click **OK**.

**Figure 9-12 Export Complete (Network Server)**

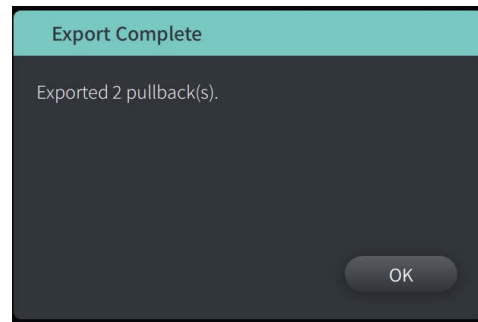

---

## Exporting Pullbacks and Images to a USB Drive

When viewing the patient record, you can export all or selected pullbacks, and export still images or movies from a particular pullback. This type of export lets you select from various formats to export to a USB drive.

---

**Note** — To improve export speed of the large Genuity image files, Genuity recommends using a USB drive that meets the USB 3.0 or newer specification.

---

### Exporting Pullbacks

This section provides information and instructions for exporting pullbacks to a USB drive.

➤ **To export pullbacks:**

1. Make sure the USB drive is inserted into the USB port on the system.
2. With the patient record displayed, select .

If the Administrator password is configured, a message is displayed, as shown in Figure 9-13. Click **Proceed** to continue. The system will prompt you for the Administrator password when you select **Export** in Step 5 below.

**Figure 9-13 Administrator Password Required**

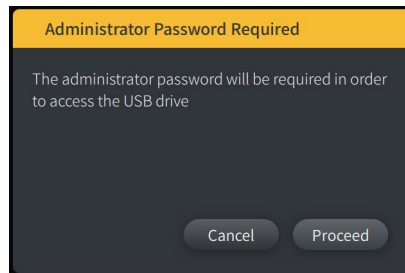

The **Patient Export** menu is displayed when you select a single patient record to export, as shown in Figure 9-14.

Figure 9-14 Patient Export Menu

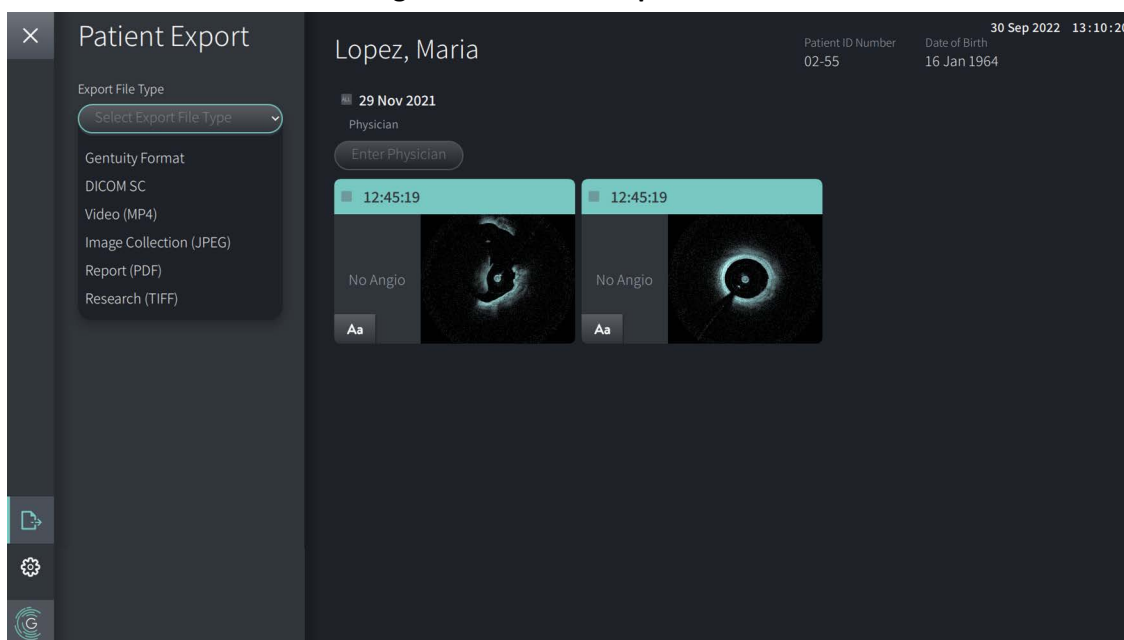

3. Do either of the following:
  - To export specific patient pullbacks, select the check box associated with each pullback. A check box is displayed in each pullback that you select.
  - To export all pullbacks, select the **ALL** button (located to the left of the date):

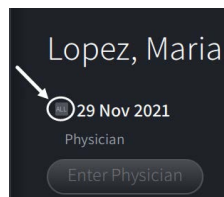

4. In the **Export Settings** section, select the file format and the export options. For details on each, see “Export File Formats” on page 9-17 and “Export Settings” on page 9-19.
5. Select **Export**. If the Administrator password is configured, the system prompts you to enter the Administrator password.

The **Select a Directory** window is displayed (Figure 9-15), prompting you to select a directory or to create a new folder for the archive.

Figure 9-15 Select a Directory

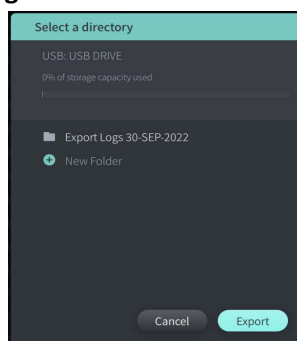

6. Select an existing directory on the USB drive, or select **New Folder** and enter the name of the new folder.
7. Click **Export**. The **Progress** screen is displayed as the records are exported from the system to the USB drive.
8. Allow the export to continue or select **Cancel** in the **Progress** screen to cancel the export.
9. When the export is complete, the **Export Complete** screen is displayed. You may remove the USB drive and then click **OK**.

## Exporting Images

This section provides information and instructions for exporting images to a USB drive.

When viewing an individual patient's pullbacks, you can configure and export the images to a USB drive. The system displays the **Configure Image** screen which shows the currently displayed image and allows you to change the composition of the display before exporting it.

### ► To export specific images:

1. Open the image to export.
2. Zoom the image for better clarity.

---

**Note** — You can adjust the image as needed before exporting.

---

3. Perform measurements and annotations as needed. For details, see “Measurements and Annotations” on page 8-1.
4. Make sure the USB drive is inserted into the USB port on the system.
5. Select  display the **Image Export** menu (Figure 9-16).

**Figure 9-16 Image Export Window**

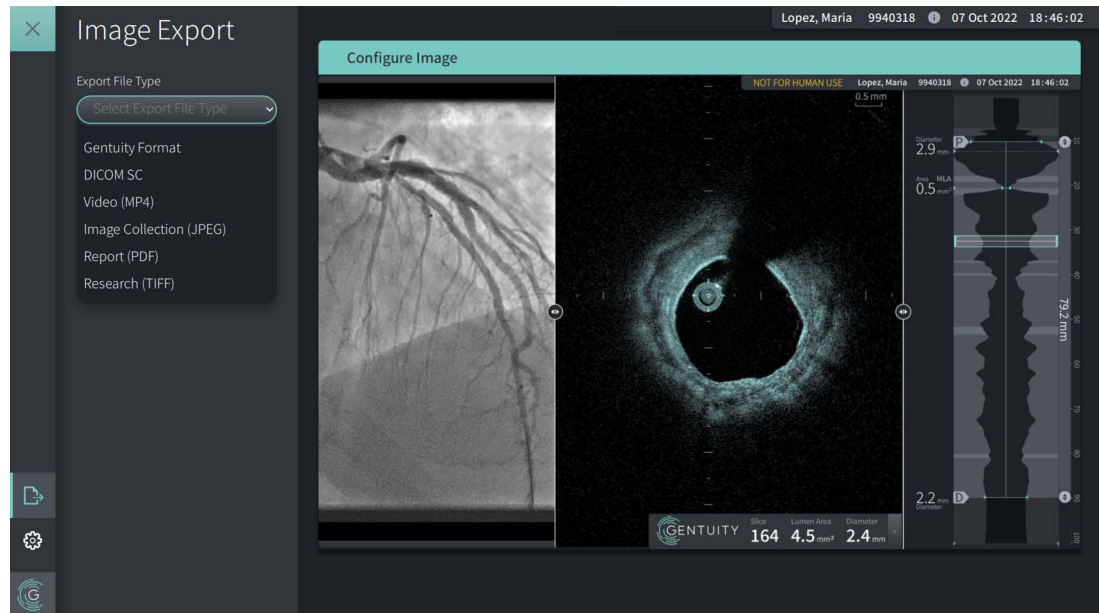

6. In the **Configure Image** window, zoom and make adjustments as needed.
7. In the **Image Export** section, select the **Export Settings** drop-down menu and then select the file format and export options. For details, see “Export File Formats” on page 9-17 and “Export Settings” on page 9-19.
8. Select **Export**. The **Select a Directory** window is displayed, prompting you to select a directory or to create a new folder for the archive.

**Figure 9-17 Select a Directory window**

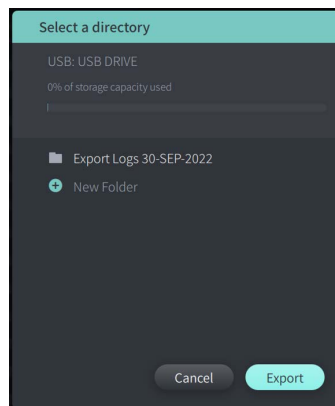

9. Select an existing directory on the USB drive, or select **New Folder** and enter the name of the new folder.
10. Select **Export**. The **Progress** window is displayed as the record is exporting from the system to the USB drive.

**Figure 9-18 Progress window**

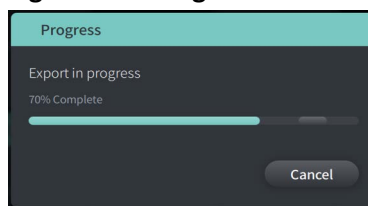

11. Allow the export to continue, or select **Cancel** to cancel the export.

---

**Note** — For details on file naming conventions for exported files, see “File Naming Conventions” on page 9-20.

---



---

## Export File Formats

An exported file can contain exactly the same data as the original file, including any measurements and annotation additions, and all patient information associated with each file. For details on what you can include and exclude in exported files, see “Export Settings” on page 9-19.

---

**Note** — When exporting to a network server, exports are always initiated from the **Patient List** and are always in DICOM file format.

---

Table 9-1 lists the formats that you can select when exporting patient records.

**Table 9-1 Export File Formats**

<b>Format</b>	<b>Description</b>	<b>Export Media Type</b>
<b>Genuity Format</b>	Proprietary file format for export.	USB Only
<b>DICOM SC</b>	DICOM compatible format for export to image archiving systems. Most Picture Archiving and Communication Systems (PACS) can accept and read DICOM SC files, but images are not calibrated for measurements. The images will show the screen layout that is currently displayed (if exporting from within the image file) or the image window layout used when the pullback was last viewed (if exporting multiple pullbacks). For details on DICOM SC file naming conventions, see "File Naming Conventions" on page 9-20.  <b>Note</b> — Genuity's DICOM Conformance Statement is available on request. Contact support@genuity.com to request a copy.	USB and Network Server
<b>Video (MP4)</b>	Exports the selected HF-OCT pullback as a series of images displayed as a movie for viewing or embedding in presentations. The movie will show the screen layout that is currently displayed (if exporting from within an image file) or the default image window layout (if exporting multiple pullbacks). Images are compressed and are not suitable for medical archiving or analysis.	USB Only
<b>Image Collection (JPEG)</b>	Creates a single image for each selected slice of the pullback. The image will show the screen layout that is currently displayed (if exporting from within an image file) or the default image window layout (if exporting multiple pullbacks). Images are compressed and are not suitable for medical archiving or analysis. When you select this export format option, you are prompted to select the export type ( <b>Full Display</b> or <b>2D Only</b> ). The <b>2D Only</b> option includes only the 2D area of the screen with no graphics.	USB Only
<b>Report (PDF)</b>	Creates a report with a single page for each image selected. Each page includes the hospital name and logo (if uploaded) and patient information in the header.	USB Only
<b>Research (TIFF)</b>	Includes only the 2D area of the screen with no graphics. When selecting this format, you are prompted to select either the <b>Cartesian</b> (8-bit) or <b>Polar</b> (16-bit) coordinate system. When exporting as Research (TIFF), only the HF-OCT image is included.	USB Only

## Export Settings

Table 9-2 lists and describes the export settings in the **Export Review/Configure Export** window when you export single or multiple patient records.

**Note** — When exporting to a network server, the only available file type option is DICOM SC.

**Table 9-2 Export Settings**

Option	Option available when selecting this File Type	Description
<b>Select File Type</b> Choose from: Genuity, DICOM SC, Image Collection (JPEG), Video (MP4), Report (PDF), or Research (TIFF)		Specifies the file format. See “Export File Formats” on page 9-17 for details.
<b>Select File Size/Quality</b>	DICOM SC, Image Collection, Report, and Video	Specifies the size and quality of the exported files. Select <b>Large/High</b> or <b>Small/Low</b> . <b>Note:</b> The larger the file size, the more space it consumes on the USB drive.
	Research (TIFF)	Specifies the size and quality of the exported files. Select <b>768</b> or <b>1200</b> .
<b>Anonymize</b>	Genuity Format, DICOM SC, Image Collection, Report, and Video  <b>Note:</b> There is no option to include patient information in a Research export, and no option to anonymize a network export.	Specifies whether Anonymize is on or off when exporting.  <b>On</b> hides (excludes) patient information in the exported files and enables the <b>Subject Identifier</b> field to enter an alternative identifier to an anonymous file.  <b>Off</b> retains (includes) patient information in the exported files.
<b>Select Format</b>	Research	Specifies the grid type for the Research export format.  Select <b>Cartesian</b> to export using a rectilinear grid. Select <b>Polar</b> to use a 2D polar grid.
	Video and Image Collection	Select from <b>Full Display</b> or <b>2D Only</b> .

Option	Option available when selecting this File Type	Description
Select <b>Slices to Export</b>	Image Collection and Report	Specifies which slices to include in the export. Select <b>Annotated Slices</b> or <b>Current Slice</b> .

---

## File Naming Conventions

When you export files to a USB drive or network server, the system generates the filenames and extensions based on the type of export and file.

For generated reports, the filename includes the date and time that the report was generated. The format is year, month, day, hour, minute, and second. To view actual patient and pullback information in the generated report, you must open the file using any PDF viewer application (not provided by Genuity). You can rename the generated report file as long as you preserve the .PDF file extension.

Files other than reports and DICOM SC exports can contain patient and pullback information in the filename. The format is: patient ID, last name, and first name, patient year of birth, month, and day, pullback year, month, day, hour, minute, second, and pullback slice number. Not all of this information is present in every filename. For example, the patient's date of birth may not have been entered in the patient record, or the Anonymize option was selected during the export. You can rename these files as long as you preserve the original file extension.

When using the **Anonymize** option to hide patient information on exported files, you can use the **Subject Identifier** option to enter alternative text as needed. For details, see Table 9-2 on page 9-19.

When exporting DICOM SC files, the system includes a file for each pullback in the export selection. The file format is GTY#####, where ##### is a sequential 5-digit number for each pullback in the export selection. For example, if you select two pullbacks for export, the files are named GTY00001 and GTY00002. The DICOM SC export also includes a DICOMDIR file along with the associated GTY files.

---

**CAUTION!** Files exported using the Genuity format have .g2raw and .patient file extensions. Changing the filename or extension of files exported using the Genuity format may result in the loss of exported information. Genuity recommends not changing these filenames or extensions.

---

# Chapter 10

## Cleaning the System

This chapter provides information and instructions for cleaning the Genuity High-Frequency OCT Imaging System and the PIM.

---

### Overview

Cleaning the Genuity High-Frequency OCT Imaging System consists of:

- Cleaning the system surfaces
  - Cleaning the PIM and its cable
- 

### Routine Cleaning Procedures

Follow your facility's standard cleaning schedule for medical devices, or clean the Genuity High-Frequency OCT Imaging System at least every 30 days under normal operation.

### Items Required for Cleaning

The following items are recommended for cleaning the Genuity High-Frequency OCT Imaging System:

- Dry cloth
- Lint-free, non-abrasive cloth
- Mild detergent
- Disinfectant wipe, Glutaraldehyde 3.4% Cidex Solution, or 70% Isopropyl Alcohol (IPA)

## Cleaning the System

### ➤ To clean the system:

1. Turn off the Genuity High-Frequency OCT Imaging System and unplug the power cable from the wall outlet.
2. Using a dry cloth, or a dry cloth that is slightly dampened with water, clean the system surfaces, keyboard, mouse, and keyboard/mouse tray.
3. Using a lint-free, non-abrasive cloth, clean the monitors' LCD surface.
4. Clean exposed system cables with a soft cloth, moistened with water or a mild detergent.

## Cleaning the PIM

---

### CAUTIONS!

- When there is no catheter connected to the PIM, be sure the PIM connector cover is securely in place to protect from dirt and damage.
  - Do not touch the internal optics of the optical connector on the catheter or on the PIM.
  - Protect the PIM connection ports and the catheter connectors from fluids.
- 

### ➤ To clean the PIM:

1. Make sure the cover is on to protect the optical connections.
  2. Clean the PIM and the PIM optical cable with a disinfectant wipe or with Glutaraldehyde 3.4% Cidex Solution or 70% IPA, and a soft cloth.
  3. Use the PIM cradle to store the PIM when not in use.
- 

**CAUTION!** When not in use, always store the PIM in the PIM cradle with the PIM connector cover facing down.

---

# Chapter 11

## Support and Maintenance

This chapter provides information about service and support for the Genuity High-Frequency OCT Imaging System. It also includes details on troubleshooting.

---

**Note** — There are no user-serviceable parts or user-required maintenance on the Genuity High-Frequency OCT Imaging System or the catheter. All service and maintenance must be performed by Genuity-authorized service representatives. It is recommended that preventive maintenance be performed on the Genuity High-Frequency OCT Imaging System annually.

---

---

### Contact Information

Genuity, LLC  
142 North Road  
Suite G  
Sudbury, MA 01776-1142  
USA

**Telephone:** 888-967-7628

**General Inquiries:** [info@genuity.com](mailto:info@genuity.com)

**Support and Service:** [support@genuity.com](mailto:support@genuity.com)

**Website:** [www.genuity.com](http://www.genuity.com)

## Troubleshooting

Table 11-1 lists issues and resolutions for troubleshooting during an HF-OCT procedure.

**Note** — If there are any concerns or issues while the PIM motor is spinning, use the red **STOP** button on the PIM or the **STOP** button on the touchscreen to stop all PIM rotation and pullback.

**Table 11-1 Troubleshooting**

Issue	Resolution
No image	Ensure adequate amount of flush delivery. For details, see “Preparing the Flush Media” on page 6-6 and “Delivering 5 ml Flush Media to Confirm Alignment” on page 6-8.
Unstable image	
Vibration	
Faint image	If the problem persists, remove the catheter and replace it with a new catheter.
No red light at catheter lens when connected	Disconnect and reconnect the catheter to the PIM.
System does not power on properly	Disconnect and reconnect the catheter to the PIM. If issue persists, remove the catheter and replace it with a new catheter.
	Remove the PIM from the PIM cradle and try restarting the system again.
Catheter connection error	The fuse(s) may need replacement. Replacement fuses are available (T5.0 (240V) - 5x20mm). Contact Genuity Support.
Forgotten password	<ol style="list-style-type: none"> <li>1. Disconnect and reconnect the catheter from the PIM.</li> <li>2. If step 1 does not resolve the issue, disconnect the catheter from the PIM and turn off the system. Power the system back on and re-connect the catheter to the PIM. If the problem persists, contact Genuity Support.</li> </ol>
Network issues	<p>If an Administrator Password has been set, that password will also allow you to log on. An Administrator can reset the password. For details, see “About the Administrator Password” on page 4-9.</p> <p>If an Administrator Password has not be set, contact Genuity Support to reset the password. For details on contacting support, see “Contact Information” on page 11-1.</p> <ul style="list-style-type: none"> <li>• Make sure the Ethernet cable is securely connected to the console and the wall or network switch.</li> <li>• Make sure the console is allowed to connect to the hospital network. If a whitelist is employed, locate the MAC address as described in “Viewing Network Adapter Information” on page 9-3. By default, the control network adapter is configured for automatic (DHCP) IP address assignment. If a static IP address is needed, contact Genuity Support.</li> <li>• External networking adapters (including USB WiFi adapters, USB Ethernet Adapters, and USB modems) are not supported.</li> </ul>



## Software Logs

In the event of an issue that requires Genuity Support, you may be asked to send software logs to further assist with the issue. For more information, see “Configuring Maintenance Settings” on page 4-17.

---

## Disposal

---

---

**WARNING!** The catheter is sterilized by irradiation and is intended for one time use only. Do not reuse, re-sterilize, or reprocess. Reuse or re-processing could result in a degradation of catheter material or patient infection.

---

---

The Imaging Catheter is a single-use item and should be disposed of after use according to your institution’s biomedical waste disposal policies.

When the Genuity High-Frequency OCT Imaging System reaches its end-of-life, disposal must be in accordance with local laws.



# Chapter 12

## Specifications

This chapter lists the technical specifications for the Genuity High-Frequency OCT Imaging System.

---

### System Specifications

This section lists the system specifications.

#### System Height and Weight

**Table 12-1 System Height and Weight**

Item	Specification
Console, including PIM (total weight)	< 70 kg (159 lb)
Maximum height (top of monitor)	155 cm (61 in)
Maximum height without monitor	115 cm (45 in)
Maximum width (base)	65 cm (26 in)
Wheel diameter (4 wheels)	10 cm (4 in)
PIM Umbilical Cable length	3.0 m (118 in)

#### Monitors

**Table 12-2 Monitors**

Item	Specification
<b>Display Monitor</b>	
Style	LCD
Size	24" diagonal
Format	Wide screen
<b>Operator Monitor</b>	
Style	LCD Touchscreen
Size	15" diagonal
Format	Wide screen

## Environmental Specifications

**Table 12-3 Environmental Specifications**

Condition	Parameter	Range
Transport and Storage	Temperature	-10°C to 45°C
	Humidity	20% RH to 95% RH (Non-condensing)
	Pressure	700 to 1060 hPa (0.7 to 1.05 atm)
Operating	Temperature	10°C to 30°C
	Humidity	20% RH to 85% RH (Non-condensing)
	Pressure	700 to 1060 hPa (0.7 to 1.05 atm)

## System Optical Specifications

**Table 12-4 System Optical Specifications: Swept Source and Visible Laser**

Specification	Description/Parameter
<b>Swept Source</b>	
Center Wavelength	1310 nm
Wavelength Sweep	≥ 70 nm, FWHM
Sweep Rate	200 kHz
Power, ex PIM	Class 1 laser output
Maximum Output Power*	< 0.5 W
<b>Visible Laser</b>	
Visible Laser Wavelength	650 nm
Visible Laser Power, ex PIM	Class 1 laser output
Maximum Output Power*	< 390 μW
* Per IEC-60825-1:2014, measured per Condition 1 and Condition 3	

---

## Clinical Imaging Specifications

**Table 12-5 Clinical Imaging Specifications**

Specification	Description/Parameter
Vessel Diameter Range	1.3 mm to 6.0 mm
Pullback Length	100 mm or 50 mm
Axial Resolution	≤ 20 um in tissue

---

## Electrical Specifications

**Table 12-6 Electrical Specifications**

Specification	Description/Parameter
Power Supply Input	100-240V AC, 50/60 Hz, 5A Max @ 100V AC
Power Cord	3 M (9 ft) cord, nominal
Voltage Withstand (PIM)	Type CF and Defib Safe
Voltage Withstand (Console)	Per IEC 60601-1

---

**Note** — Replacement fuses are available (T5.0 (240V) - 5x20mm). The system console requires two fuses. For more information, contact Genuity Customer Support.

---

## Safety Standards Compliance

The Genuity High-Frequency OCT Imaging System complies with the following national and international standards:

- EN 60601-1-2 (2015) (Europe)
- IEC 60601-1-2 (2014) (US and International)

# Chapter 13









## Glossary of Symbols

This chapter lists and describes the symbols and icons that may appear on the Gentyuty High-Frequency OCT Imaging System and the Imaging Catheter and their packaging.

### System Symbols

Table 13-1 lists and describes the symbols that may appear on the Gentyuty High-Frequency OCT Imaging System.

**Table 13-1 System Symbols**

Symbol	Title	Explanatory Text	Reference to Standard	Designated or Reference Number
	Authorized representative in the European Community/ European Union	Indicates the authorized representative in the European Community/ European Union	Reference 1	5.1.2
	United Kingdom Responsible Person	Indicates the person who acts on the manufacturer's behalf in the United Kingdom for UK MDR	--	--
	Unique device identifier	Indicates a carrier that contains unique device identifier information	Reference 1	5.7.10
	Medical device	Indicates this item is a medical device	Reference 1	5.7.7
	Catalogue number	Indicates the manufacturer's catalogue number so that the medical device can be identified	Reference 1	5.1.6
	Date of manufacture	Indicates the date when the medical device was manufactured	Reference 1	5.1.3
	Country of manufacture	Indicates the country where the medical device was manufactured	Reference 1	5.1.11
	Serial number	Indicates the manufacturer's serial number so that a specific medical device can be identified	Reference 1	5.1.7

**Table 13-1 System Symbols (Continued)**









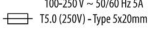

Symbol	Title	Explanatory Text	Reference to Standard	Designated or Reference Number
	Fuse	Identifies the location of the fuse	Reference 2	5016
	Equipotential	Identifies the equipotential grounding post	Reference 2	5021
	Refer to instruction manual	Indicates that the instruction manual must be read	Reference 3	M002
	Bureau Veritas NRTL	Electrical Safety Testing Laboratory	--	--
	Manufacturer	Indicates the medical device manufacturer	Reference 1	5.1.1
TRIGGER	Not used	--	--	--
	USB	Indicates the port for USB (Universal Serial Bus) compatible devices		
REMOTE	Not used	--	--	--
	Computer network	Identifies the connecting terminal to the computer network	Reference 2	5988
	Video input	Identifies video equipment input controls and connecting terminals	Reference 2	5525B
	Video output	Identifies video equipment output controls and connecting terminals	Reference 2	5529B
	Defibrillation Proof	Identifies a defibrillation-proof type CF applied part complying with IEC 60601-1	Reference 2	5336
	Standby	Identifies the switch by means of which the equipment is switched on in order to bring it into the stand-by condition	Reference 2	5009







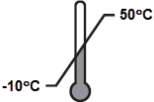



Table 13-1 System Symbols (Continued)

Symbol	Title	Explanatory Text	Reference to Standard	Designated or Reference Number
				<b>Reference 1:</b> EN ISO 15223-1:2021 <b>Reference 2:</b> IEC TR 60878:2022 <b>Reference 3:</b> ISO 7010:2019



## System Packaging Symbols

Table 13-2 lists and describes the symbols that may appear on the Genuity High-Frequency OCT Imaging System packaging.

**Table 13-2 System Packaging Symbols**

Symbol	Title	Explanatory Text	Reference to Standard	Designated or Reference Number
	Catalogue number	Indicates the manufacturer's catalogue number so that the medical device can be identified	Reference 1	5.1.6
	Keep dry	Indicates a medical device that needs to be protected from moisture	Reference 1	5.3.4
	This way up	Indicates the correct upright position	Reference 2	0623
	Fragile, handle with care	Indicates a medical device that can be broken or damaged if not handled carefully	Reference 1	5.3.1
	Temperature limit	Indicates the temperature limits to which the medical device can be safely exposed	Reference 1	5.3.7
	Humidity limitation	Indicates the range of humidity to which the medical device can be safely exposed	Reference 2	5.3.8
	Atmospheric pressure limitation	Indicates the range of atmospheric pressure to which the medical device can be exposed	Reference 2	5.3.9
	Date of manufacture	Indicates the date when the medical device was manufactured	Reference 1	5.1.3

**Table 13-2 System Packaging Symbols (Continued)**

<b>Symbol</b>	<b>Title</b>	<b>Explanatory Text</b>	<b>Reference to Standard</b>	<b>Designated or Reference Number</b>
	Country of manufacture	Indicates the country where the medical device was manufactured	Reference 1	5.1.11
	Serial number	Indicates the manufacturer's serial number so that a specific medical device can be identified	Reference 1	5.1.7
	Manufacturer	Indicates the medical device manufacturer	Reference 1	5.1.1
<p><b>Reference 1:</b> EN ISO 15223-1:2021</p> <p><b>Reference 2:</b> IEC TR 60878:2022</p>				

## Catheter Symbols

Table 13-3 lists and describes the symbols that may appear on the Imaging Catheter or its packaging and labeling.

**Table 13-3 Catheter Symbols**









Symbol	Title	Explanatory Text	Reference to Standard	Designated or Reference Number
	Authorized representative in the European Community/ European Union	Indicates the authorized representative in the European Community/ European Union	Reference 1	5.1.2
	United Kingdom Responsible Person	Indicates the person who acts on the manufacturer's behalf in the United Kingdom for UK MDR	--	--
	Medical device	Indicates this item is a medical device	Reference 1	5.7.7
	Single sterile barrier system with protective packaging inside	Indicates a single sterile barrier system with protective packaging inside	Reference 1	5.2.13
	Single sterile barrier system	Indicates a single sterile barrier system	Reference 1	5.2.11
	Caution	Indicates that caution is necessary when operating the device or control close to where the symbol is placed, or that the current situation needs operator awareness or operator action in order to avoid undesirable consequences.	Reference 1	5.4.4
	Date of manufacture	Indicates the date when the medical device was manufactured	Reference 1	5.1.3
	Country of manufacture	Indicates the country where the medical device was manufactured	Reference 1	5.1.11

Table 13-3 Catheter Symbols (Continued)





















Symbol	Title	Explanatory Text	Reference to Standard	Designated or Reference Number
	Catalogue number	Indicates the manufacturer's catalogue number so that the medical device can be identified	Reference 1	5.1.6
	Batch code	Indicates the manufacturer's batch code so that the batch or lot can be identified	Reference 1	5.1.5
	Consult instructions for use	Indicates the need for the user to consult the instructions for use	Reference 1	5.4.3
	Keep dry	Indicates a medical device that needs to be protected from moisture	Reference 1	5.3.4
	Do not use if package is damaged	Indicates a medical device that should not be used if the package has been damaged or opened	Reference 1	5.2.8
	Do not re-use	Indicates a medical device that is intended for use on a single patient during a single procedure	Reference 1	5.4.2
	Do not re-sterilize	Indicates a medical device that is not to be re-sterilized	Reference 1	5.2.6
	Keep away from sunlight	Indicates a medical device that needs protection from light sources	Reference 1	5.3.2
	Sterilized using irradiation	Indicates a medical device that has been sterilized using irradiation	Reference 1	5.2.4
	Sterilized using ethylene oxide	Indicates a medical device that has been sterilized using ethylene oxide	Reference 1	5.2.3
	Use by date	Indicates the date after which the medical device is not to be used	Reference 1	5.1.4

Table 13-3 Catheter Symbols (Continued)

Symbol	Title	Explanatory Text	Reference to Standard	Designated or Reference Number
	Quantity	Indicates the quantity of an item contained in the package	--	--
	Atmospheric pressure limitation	Indicates the range of atmospheric pressure to which the medical device can be safely exposed	Reference 1	5.3.9
	Temperature limit	Indicates the temperature limits to which the medical device can be safely exposed	Reference 1	5.3.7
	Guide Catheter compatibility	Defines the minimum guide catheter inner diameter	--	--
	Guidewire compatibility	Defines the maximum guidewire outer diameter	--	--
	Packaging unit	Indicates the number of pieces in the package	Reference 2	2794
	Injection syringe	Indicates a reference to an injection syringe	Reference 2	5382
	Remove before use	Indicates a part which should be removed before using the catheter	--	--
	Open here	Indicates the location where the package can be opened	--	--
<p><b>Reference 1:</b> EN ISO 15223-1:2021</p> <p><b>Reference 2:</b> IEC TR 60878:2022</p>				

## Numerics

- 2D view, 7-6
- 3D view, 7-20, 7-21

## A

- Accessing Patient List, 5-1
- Acquisition sequence, beginning, 6-4
- Acquisition settings, configuring, 4-14
- Adding a patient record, 5-2
- Adding annotations, 8-8
- Administrator password, configuring, 4-9
- Angio view, 7-4
- Angiography
  - connecting video from, 4-5
  - image view, 7-5
- Angle measurements, 8-9
- Annotations
  - adding, 8-8
  - overview, 8-8
- Anonymize, 9-19
- Area measurements
  - overview, 8-6
  - performing, editing, and deleting, 8-7, 8-10
- Areas of Uncertainty, 7-8
- Automated injector, 6-6
- Automatic Flush Detection, 6-5, 6-10

## B

- Backup settings, configuring, 4-17
- Bifurcation tool, 7-18
- Bookmark, 7-11

## C

- Cartesian, 9-19
- Catheter
  - connecting to PIM, 6-3
  - packaging symbols, 13-4, 13-6
  - troubleshooting connection error, 11-2
- Cleaning
  - items required for, 10-1
  - PIM, 10-2
  - routine procedures, 10-1
  - system, 10-2
- Clinical imaging specifications, 12-3
- Color Map, selecting, 4-16
- Completing the exam, 6-11
- Complications, 1-2
- Components

- PIM, 3-5
  - system, 3-2

## Configuring

- Acquisition settings, 4-14
- Administrator password, 4-9
- backup settings, 4-17
- Color Map, 4-16
- Date & Time, 4-10
- General settings, 4-10
- Hospital Information, 4-11
- Lock Screen, 4-13
- Log Off Timer, 4-11
- Maintenance settings, 4-17
- Network Export Server(s), 9-4
- Physician names, 4-11
- required information, 4-12
- Review settings, 4-16
- system settings, 4-8
- User password, 4-12

## Connecting

- external monitor, 4-4
- video input from angiography system, 4-5

## Connections, system input/output, 3-4

## Contacting Genuity, 11-1

## Contraindications, 1-1

## Conventions, documentation, 1-3

## Current Slice Indicator, 7-10

## Current Slice Information Panel, 7-7

## Cybersecurity, 2-12

## D

## Database Export screen, 9-7

## Date & Time, configuring, 4-10

## Date, exporting patient records by, 9-8

## Deleting

- annotations, 8-8
- area measurements, 8-7, 8-10
- linear measurements, 8-5
- Patient Record, 5-6, 5-7
- patient records after export, 9-9
- pullbacks, 5-6

## Device requirements, 12-1

## DICOM PACS server, configuring, 9-3

## DICOM SC, 9-18

## Display monitor, adjusting, 4-4

## Disposal, 11-3

## Distal Slice Reference Marker, 7-10

## Document conventions, 1-3

## **E**

- Editing a patient record, 5-6
- Electrical specifications, 12-3
- Electromagnetic emissions, 2-9
- Electromagnetic immunity, 12-3
- Electromagnetic Interference, 2-7
- Enabling high-speed rotation, 6-9
- Environmental specifications, 12-2
- Equipment, required materials and, 6-2
- Ethernet port, 3-4
- Exam, completing, 6-11
- Export icon, 7-4
- Export settings, 9-19
- Exporting
  - Anonymizing patient records, 9-19
  - deleting patient records after, 9-9
  - file formats, 9-17
  - images to USB drive, 9-15
  - patient records by date, 9-8
  - patient records (multiple), 9-7
  - pullbacks, 9-12
  - pullbacks and images to USB drive, 9-12
  - via USB connected media, 9-1
- External monitor, connecting, 4-4

## **F**

- File formats, 9-17
- File Size/Quality, 9-19
- Flush Media
  - confirming type, 6-5
  - injecting, 6-10
  - preparing, 6-6
- Fly-Through view, 7-21
- Fuses, replacement, 12-3

## **G**

- General settings, configuring, 4-10
- Genuity Format, 9-18
- Guide catheter, 7-8

## **H**

- High-speed rotation, enabling, 6-9
- Hospital Information, configuring, 4-11

## **I**

- Image Collection (JPEG), 9-18
- Image screen, 7-2
- Images
  - exporting, 9-15
  - reviewing pullback, 7-1
- Imaging Settings window, 6-5, 6-7, 6-8
- Indications for use, 1-1

- Initiating pullback, 6-10
- Injecting flush media, 6-10
- Injection type, 6-6
- Intended use, 1-1

## **J**

- JPEG, 9-18

## **L**

- Limitations, view mode, 7-19
- Linear measurements
  - Measurements Results Tag, 8-11
  - overview, 8-4
  - performing, editing, and deleting, 8-5
- L-Mode view, 7-19
- Lock Screen, setting, 4-13
- Log Off Timer, configuring, 4-11
- Log On window, 4-2
- Logging onto system, 4-2
- Logging out of system, 4-3
- Longitudinal Distance, 7-9
- Lumen boundary, 7-6
- Lumen Profile display, 7-8
- Lumen trace, 7-6

## **M**

- Maintenance settings, configuring, 4-17
- Manual injection, 6-6
- Markers
  - Annotation, 7-10
  - Bookmark, 7-10
  - Distal Slice Reference, 7-10
  - Longitudinal distance, 7-10
  - Measurement, 7-10
  - Proximal Slice Reference, 7-9
  - Reference, 7-11

## **Measurements**

- performing angle, 8-9
- performing area, 8-7, 8-10
- performing linear, 8-5
- techniques to improve accuracy, 8-3

## **Menu Bar, 7-4**

## **Minimum, 7-8, 7-10**

## **Monitor**

- adjusting display, 4-4
- connecting external, 4-4
- specifications, 12-1

## **Moving the system, 2-6**

## **N**

- Navigating the pullback, 7-12
- Network Adapter Information, viewing, 4-18, 9-3
- Network Export Server



- adding, 9-4
- configuring, 4-18
- editing and testing, 9-6
- Network issues, troubleshooting, 11-2
- O**
- OCT procedure
  - beginning acquisition sequence, 6-4
  - completing, 6-11
  - overview, 6-1
  - required materials and equipment, 6-2
  - setting up system for, 6-2
- OCT recordings, reviewing, 7-1
- On/Shut Down button, 4-3
- Opening a patient record, 5-5
- P**
- Passwords
  - Administrator, 4-9
  - troubleshooting forgotten, 11-2
  - User, 4-12
- Patient List
  - accessing, 5-1
  - exporting patient records from, 9-8
  - sorting columns, 5-4
- Patient Records
  - adding, 5-2
  - anonymizing during export, 9-19
  - configuring required information, 4-12
  - deleting, 5-6, 5-7
  - deleting a pullback, 5-6
  - deleting after export, 9-9
  - editing, 5-6
  - exporting by date, 9-8
  - exporting multiple, 9-7
  - opening, 5-5
  - overview, 5-1
  - pinning, 5-7
  - searching for, 5-4
- Patient safety, 2-1, 2-2, 6-6
- PDF, 9-18
- Physicians, configuring names, 4-11
- Pinning a patient record, 5-7
- Positioning the system, 4-1
- Preparing Flush Media, 6-6
- Probe Interface Module (PIM), 3-5
  - cleaning, 10-2
  - components, 3-5
  - connecting catheter to, 6-3
  - enabling start of high-speed rotation, 6-9
- Procedure Room, selecting, 4-6
- Proximal Slice Reference Marker, 7-9
- Pullback Settings, 6-4
- Pullbacks
  - adding annotations, 8-1, 8-8
  - deleting, 5-6
  - exporting, 9-12
  - exporting to USB drive, 9-12
  - initiating, 6-10
  - navigating, 7-12
  - performing a linear measurement, 8-5
  - performing an area measurement, 8-7, 8-10
  - performing measurements, 8-1
  - reviewing images, 7-1
  - settings, 6-5
  - viewing information, 7-22
- R**
- Replacement fuses, 12-3
- Report (PDF), 9-18
- Repurge Reminder, 4-15
- Required Information, configuring, 4-12
- Requirements, device, 12-1
- Research (TIFF), 9-18
- Review settings, configuring, 4-16
- Reviewing OCT recordings, 7-1
- S**
- Safety
  - patient, 2-1, 2-2, 6-6
- Safety Standards Compliance, 12-4
- Searching for patient records, 5-4
- Security
  - Gentuity controls, 2-12
  - recommended practices, 2-13
- Selecting procedure room, 4-6
- Separation distances, 2-9
- Settings
  - configuring Acquisition, 4-14
  - configuring General, 4-10
  - configuring Maintenance, 4-17
  - configuring Review, 4-16
  - export, 9-19
- Settings icon, 7-4
- Settings screen, 4-8
- Shut Down button, 4-3
- Software, viewing current version, 4-17
- Sorting Patient List columns, 5-4
- Specifications
  - clinical imaging, 12-3
  - device requirements, 12-1
  - electrical, 12-3
  - environmental, 12-2
  - monitor, 12-1
  - overview, 12-1
- Stent Expansion, 7-16
- Stopping high-speed rotation, 6-9

- Storage Capacity, viewing, 4-11
- Subject Identifier, 9-19
- Survey, 100mm, 2 seconds, 6-4
- Symbols, 13-1
  - catheter packaging, 13-4, 13-6
  - system, 13-1
- System
  - built-in safety functions, 2-6
  - cleaning, 10-2
  - cleaning and maintaining, 10-1
  - components, 3-1, 3-2
  - configuring settings, 4-8
  - fuses, 12-3
  - height and weight, 12-1
  - input/output connections, 3-4
  - logging in, 4-2
  - logging out, 4-3
  - Menu Bar, 7-4
  - moving, 2-6
  - OCT procedure overview, 6-1
  - overview, 3-1
  - positioning, 4-1
  - setting up for OCT procedure, 6-2
  - specifications, 12-1
  - symbols, 13-1
  - troubleshooting, 11-2
  - viewing current software version, 4-17
  - viewing storage capacity, 4-11
- System Information, viewing, 4-17

**T**

- Testing Network Export Server, 9-6
- TIFF, 9-18
- TLS Encryption, 9-5
- Tools
  - Angle measurements, 8-9
  - Annotation, 8-8
  - Area measurement, 8-6
  - Bifurcation, 7-18
  - linear measurement, 8-4
  - measurement and annotation, 8-2
  - Stent Edit, 7-17
  - Stent Expansion, 7-16, 7-17
- Training Mode, 4-11
- Transport Layer Security (TLS) Encryption, 9-5
- Troubleshooting, 11-2

**U**

- USB Media, 9-2, 9-12
  - exporting via, 9-1
  - restricting access, 9-2
- User password, configuring, 4-12

**V**

- Very low confidence slice, 7-15
- Vibration, troubleshooting, 11-2
- Video input, connecting from angiography system, 4-5
- View modes
  - 3D, 7-20, 7-21
  - limitations, 7-19
  - L-Mode, 7-19
  - overview, 7-16
- Viewing
  - pullback information, 7-22
  - system information, 4-17
  - system storage capacity, 4-11
- Views
  - 2D, 7-6
  - 3D, 7-20, 7-21
  - Angio, 7-4
  - L-Mode, 7-19

**Z**

- Zoom Indicator, 7-9